



Public Address - Voice Alarm

Audio Distribution over IP

Loudspeakers



# BOUTIQUE™

Compact and Self-Amplified PA/VA System

# CATALOGUE

DELIVERING YOUR MESSAGE



## DELIVERING YOUR MESSAGE

ATEIS has over 30-years of experience in researching, designing, development and supplying of Public Address and Voice Alarm Evacuation Systems.

As a leading company in the PA/VA industry, our mission is to provide our customers with easy-to-use and complete EN 54-16 and EN 54-4 solution. Our experienced R&D and customer/technical support teams are able to implement and respond rapidly to the demands of our various vertical markets.



Our vision is to create inspiring products and invent dedicated technologies for our customer's and markets demands. We are a group of passionate people, working with integrity to help our customers worldwide being able to find the perfect PA/VA solution for each project.

# CONTENTS



## BOUTIQUE PA/VA SYSTEM

- **FEATURES** ..... 04

## CONTROLLERS

- PAVA Controller, 4 Zones  
**BTQ-VM425 / BTQ-VM450** ..... 08
- PAVA Controller, 8 Zones  
**BTQ-VM825 / BTQ-VM850** ..... 08
- WallMount PAVA Controller  
**BTQ-VM425W1 / BTQ-VM825W1**  
**BTQ-VM450W1 / BTQ-VM850W1**  
**BTQ-VM425W2 / BTQ-VM825W2**  
**BTQ-VM450W2 / BTQ-VM850W2** ..... 11

## SECONDARY UNITS

- PAVA Secondary Global Unit, 8 Zones  
**BTQ-SG8** ..... 13
- PAVA Secondary Local Unit, 8 Zones  
**BTQ-SL8** ..... 15

## AMPLIFIERS & BATTERY CHARGERS

- Bridging Power Amplifier  
**BPA** ..... 19
- Digital Power Amplifier  
**DPA** ..... 21
- Advanced Monitored Battery Charger  
**BCU-4830A / BCU-4875A** ..... 23

## DIGITAL PAGING CONSOLES

- Digital Redundant Loop Paging Microphone-Main  
**DPM-MAIN** ..... 25
- EVAC Unit with Speaker and Extra Buttons  
**DPM-EVA** ..... 25
- Additional 8+1 Microphone Keypad  
**DPM-KPD** ..... 25
- 5" TouchPanel Paging Mic Console  
**DPM-T5** ..... 27
- 5" TouchPanel Paging Mic Console w/EVAC Button  
**DPM-T5F** ..... 27
- WallMount Paging Mic Console, 8/16 keys, EVAC Button  
**CD-8DF / CD-16DF** ..... 28
- WallMount 5" TouchPanel Paging Console, EVAC  
**CD-T5DF** ..... 29

## ACCESSORIES

- Noise Sensing Microphone  
**DNM2-ETH / DGL-MIC** ..... 31
- Digital Loop Repeater  
**DLR01 / DLPJ** ..... 32
- Volume Attenuator  
**VAT** ..... 33
- Dummy Load Capacitor Module  
**VA-DLC-100 / VA-DLC-70** ..... 33
- End of SP-line Module for Multi-branch/3-wire  
**VA-EOL** ..... 34
- 3 Wire Speaker Line Short Sensor  
**SL-SENSOR2 / SL-SENSOR4** ..... 34
- 20kHz Signal Blocker  
**BLKR-60 / BLKR-200** ..... 34

## SYSTEM SOFTWARE

- **Web Browser Based Configuration and Control** ..... 36



# BOUTIQUE FEATURES

EVERY EFFORT HAS BEEN MADE TO PROVIDE THE BEST SOLUTION



## SCALABLE

BOUTIQUE is suitable for any installation size, whether is a small local system or a big complex multi-zone and multi-input system. It can expand as little as 4 zones or be networked up to 16,384 A/B zones via ATEIS "global network" over either CAT5/6 cable (up to 100M between units) or via multi-mode (2 KM), single mode (20 KM) fibre optics or even longer distance, and this simple yet powerful design that gives BOUTIQUE a unrivalled scaling capability.

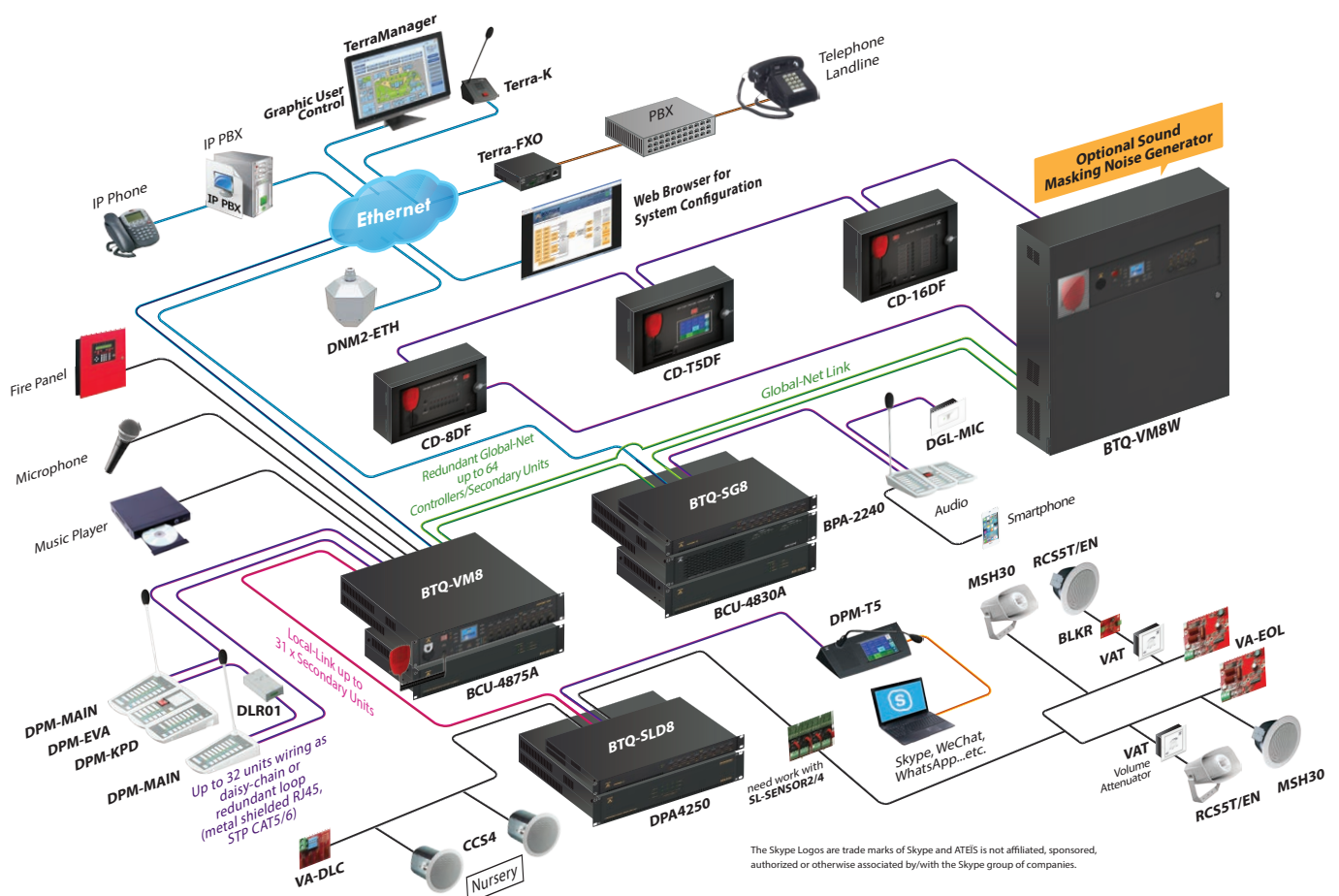

# BOUTIQUE FEATURES

## SYSTEM SOLUTIONS



### **COST-EFFECTIVE, EASE OF INSTALLATION AND CONFIGURATION**

For most PA/VA installation, we understand how much work it takes to complete all the installations, here we represent the system "setup wizard" function, the system can be easily setup and replacement from front panel. BOUTIQUE delivers outstanding technologies including powerful DSP, global-net redundancy, intelligent switchable amplifier management, high efficiency Class-D amplifier built-in and advanced controls via web browser. This can help you save your time, labor cost and material cost with the benefit of easy installation.

### **CONTROL, MANAGEMENT AND MONITORING VIA WEB BROWSER**

Whether it is in a control room from the main building or in a control facility several kilometers away, the operator can control and supervise the entire BOUTIQUE system remotely from web browser, further adjustments such as volume, DSP elements, zone setting, event and bell scheduler, paging with priority management, monitor, logging etc. can now be made without any previous design effort.



### **NETWORK REDUNDANCY**

Based on ATEIS redundant network technology, BOUTIQUE takes reliability to the next level with a network redundancy architecture that offers the best network protection of system failure. If one of network cables occurs unexpected disconnection, the redundant network will recover the communication to make system continually functional. In addition, the paging consoles can be wired in daisy chain or as a redundant loop to ensure a secured application.

### **OPEN INTEGRATED STRUCTURE**

The VoIP interface with standard SIP protocol allows easy integration with IP-PBX and IP phone; or for full integration with Terracom network paging and control intercom system. Moreover, BOUTIQUE also allows integration with third party control via RS232 and Ethernet.



### **EXCELLENCE IN AUDIO QUALITY AND DSP PROCESSING**

BOUTIQUE is at the same time, a professional audio system with the latest DSP processing technology such as auto gain control (AGC), ambient noise sensing mic (dynamic/static type), PEO, Compressor, Limiter etc. which add up the advantages for message paging, general audio routing with multiple zones.

### **ECO-FRIENDLY PRODUCT**

A completed BOUTIQUE system including controller, secondary unit, power amplifier and paging console are with extremely low power consumption during standby mode, this makes BOUTIQUE an eco-friendly product and reduce the energy consumption considerably.



### **SPEAKER LINES MONITORING**

By installing the VA-EOL end of SP-line module for multi-branch, the system can adapt the changing impedance when adjusting multiple VAT volume attenuators without the need for a loopback cable. The system can indicate which speaker line is open/short circuit within 90 seconds (EN 54-16 requirement), helping to save the analysis time.

# BOUTIQUE™

## PA/VA Controllers



The BOUTIQUE controller is an integrated, cost-effective, highly scalable and flexible PA/VA system specifically designed for a wide variety of projects. It has all the essential functionality to comply with EN 54-16 requirements (certification in process) including full system monitoring, loudspeaker line impedance surveillance, microphone capsule surveillance and monitored interfacing with remote devices etc.

### BTQ-VM4

PAVA Controller, 4 Zones



250W/500W Class-D amp built-in

### BTQ-VM8

PAVA Controller, 8 Zones



250W/500W Class-D amp built-in

### BTQ-VM4W

WallMount PAVA Controller, 4 Zones



250W/500W Class-D amp & battery charger built-in

### BTQ-VM8W

WallMount PAVA Controller, 8 Zones

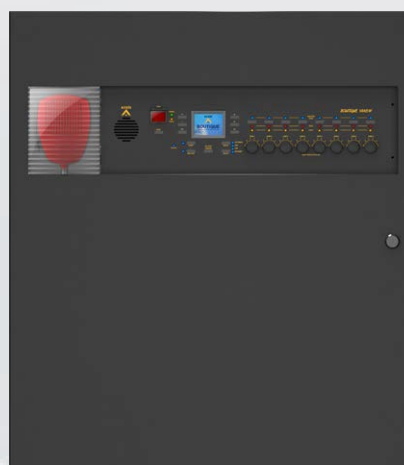

250W/500W Class-D amp & battery charger built-in



# Secondary Units

The BTQ-SL8/BTQ-SG8 PAVA secondary unit is an extension unit for BOUTIQUE controller. It increases the number of zones by a further 8 speaker zones, additional digital console ports, logic control inputs and relay control outputs. The BTQ-SL8 secondary local unit is connected to the BTQ-VM4/VM8 controller via via a dedicated digilink local network, and the BTQ-SG8 secondary global unit can increase the number of zones using global-network via standard CAT5/6 cable or fiber optics.

## BTQ-SG8

PAVA Secondary Global Unit, 8 Zones



## BTQ-SL8

PAVA Secondary Local Unit, 8 Zones



# PA/VA Controllers

IN PROCESS

EN54  
16

## BTQ-VM4 / BTQ-VM8

### PAVA Controller

BTQ-VM425 / BTQ-VM450



BTQ-VM825 / BTQ-VM850



The BTQ-VM4/BTQ-VM8 controllers offer 4 and 8 monitored speaker zones respectively. Each controller can cascade with up to 31 BTQ-SL8 secondary units via local digilink, and up to 64 x BTQ-VM4/VM8/SG8 via global-net. This will then extend as little as 4 monitor A/B speaker zones to a large networked system of up to 16,384 zones. The BTQ-SL8 is linked to the controller via STP CAT5/6 cable with metal shielded RJ45 connector (max. length 100M between units); and the BTQ-SG8 is linked to BTQ-VM4/8 via CAT5/6 cable (max. length 100m between units), multi-mode (2 km) and single-mode (20 km) fibre optics or even longer distance.

The BOUTIQUE system can be installed and configured with ease of operation, including easy setup and replacement from LCD front panel. Operational versatility such as volume, PEQ, audio routing, monitor and control, event and bell scheduler, paging with priority management (1~99 priority level) etc. can be configured by a dedicated ATEIS web browser. In addition, the BOUTIQUE system has full digital audio matrix and an internal message storage for up to 90 minutes and a USB interface for configuration backup.

In accordance with EN 54-16 requirement, all BOUTIQUE system including paging microphones and loudspeaker lines provides full monitoring and fault reports. The controller is also an eco-friendly product with extremely low power consumption during standby mode (6.5W). In addition, multiple volume attenuators can be installed on a monitored speaker lines without the need for a loopback cable. For branching speaker lines using the VA-EOL module, please order the "EOL driver" version of BTQ unit such as BTQ-VMD/SGD/SLD controller/secondary unit, in order to provide more power to drive the VA-EOL module.

## FEATURES

- Support as little as 4 zones to a large 16,384 zones using global network of BTQ-VM8/SG8
- 250W or 500W high efficiency Class-D amplifier built-in
- Full DSP system with superior audio quality
- Control, management and monitoring via web browser
- Both background music playing and paging can be simultaneously proceeded
- IP based music streaming and paging over LAN/WAN
- Easy integration with Terracom, TerraManager and IP phone via SIP protocol
- Internet radio receiver built-in
- Low cost 2 channel switching amplifier architecture
- VAT volume attenuators can be installed on monitored speaker lines without the need for a loopback cable
- Integrated ambient noise sensing for auto audio level
- 2.2" LCD colour display for system status and configuration setting
- Third party control via RS232 or Ethernet
- Optional Sound Masking module - reduce the intelligibility of human speech for protecting private speech privacy



# PA/VA Controllers



## Installation Notes

The BOUTIQUE controller is fully integrated with 250W or 500W high efficiency Class-D amplifier built-in and is capable of handling 1000W speaker load per zone and 2000W max. per unit. Targeted at scalable small to large sized facilities, the controller has 10 audio sources: 2 music inputs: 1 mic/line input, 1 USB input, SIP call in, 1 fireman microphone and 2 digital paging and control interfaces. Each digital paging interface provides 2CH audio inputs to simultaneously transmit bi-directional data communication in digital format. The remote ports can be wired in a daisy chain or a redundant loop. The mic/line input features VOX function (Voice Activation) and each input is fitted with volume controls and equalizers.

### INTERFACE

- BTQ-VM4: Five monitored EVAC inputs, four relay control outputs, one fault relays and one EVAC relay output
- BTQ-VM8: Nine monitored EVAC inputs, eight logic control inputs and eight relay control outputs, one fault relays and one EVAC relay output

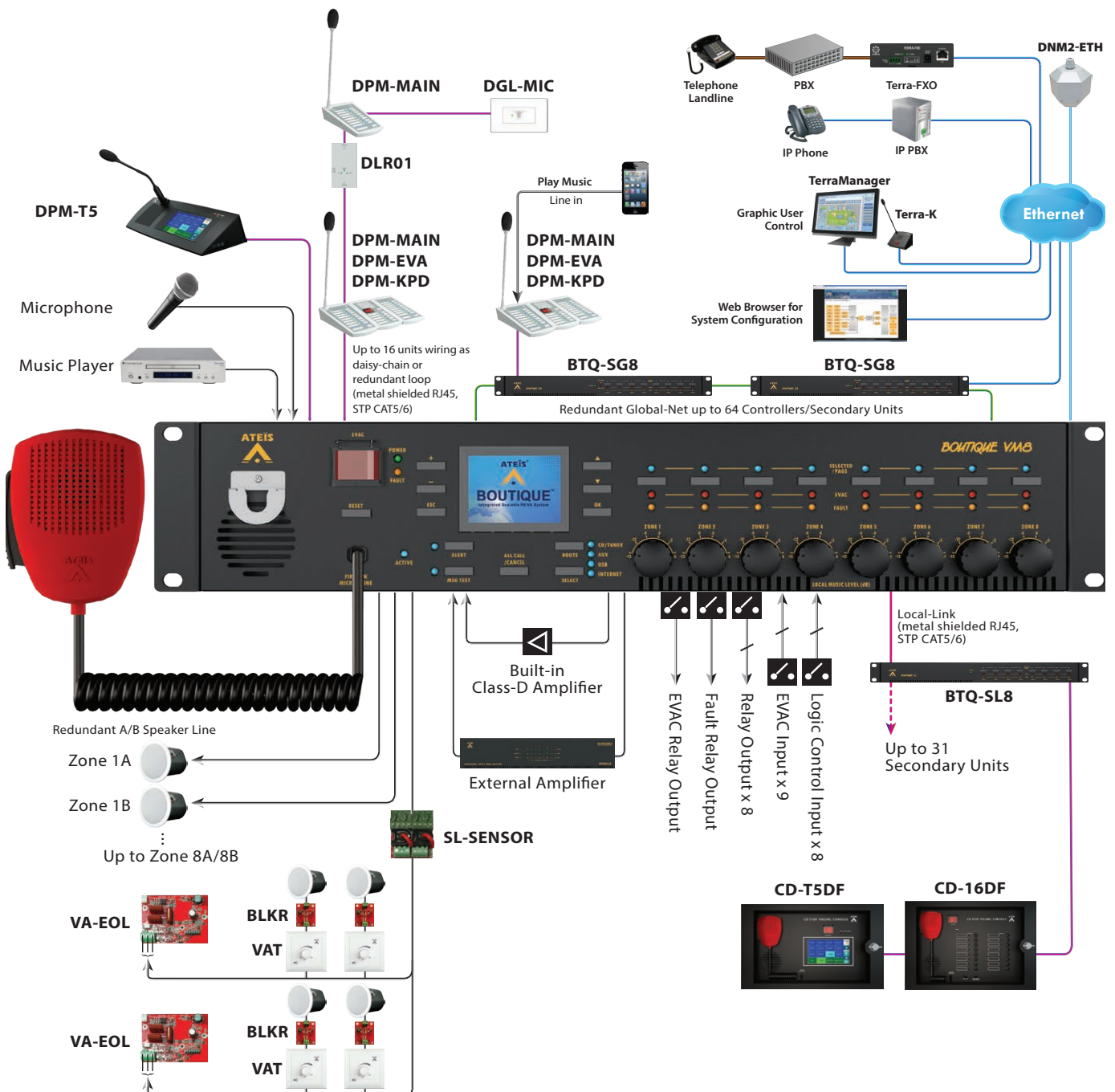

## BTQ-VM4 / BTQ-VM8

### Technical Specifications

#### PA/VA CONTROLLER

##### ■ Front (4/8 zones type)

- 2.2" full colour touch screen LCD display
- 1 evacuation button
- Reset/route/select button
- Monitoring speaker
- 4/8 zone selected buttons and LEDs
- 4/8 zone EVAC LEDs
- 4/8 zone alert page LEDs
- 4/8 BGM source status LEDs (CD/TUNER, AUX, USB, INTERNET)
- 4/8 zone volume control knobs
- 1 all-call and all-call cancel button
- Status LED (power/fault/fireman MIC active/Alert/MSG testing)

##### ■ Back

- 2 DIP switches for VOX and phantom power
- 2 global-net port LEDs

#### INTERCONNECTIONS

##### ■ Front

- Fireman microphone

##### ■ Back (4/8 zones type)

- AC power cord socket
- 48 VDC backup power input
- 5/9 monitored EVAC inputs
- 4/8 speaker zone(A/B) outputs
- 4/8 relay control outputs
- 8 monitored logic control inputs (BTQ-VM8)
- 1 fault relays & 1 EVAC relay output
- 2 digital ports for paging console
- 1 MIC/LINE XLR 3-pin phoenix input and 2 RCA stereo input
- 1 audio line output
- 1 external amp input
- 1 set of digilink loop port (BTQ-VM4/8 to BTQ-SL8 link)
- 1 set of global-net port (optional)
- 1 Ethernet port
- 1 USB 2.0 for configuration backup and message/music file
- 1 internal amp output (100V)
- 1 external amp output
- 24 VDC output
- RS232 for third party control

#### CERTIFICATIONS AND APPROVALS

Europe	Voice Alarm	EN 54-16 (In process)
Europe	CE/EMI	EN 55032
Europe	CE/EMC	EN 61000-3-2 EN 61000-3-3 EN 55020
Europe	CE/LVD	EN 60065
USA	Safety	UL 60065 (In process)

#### ELECTRICAL

- AC power input: 100 VAC ~ 240 VAC, 50/60 Hz
- Power consumption (AC)

model	idle	1/2 full power	full power
BTQ-VM425 BTQ-VM825	24VA	195VA	360VA
BTQ-VM450 BTQ-VM850	24VA	345VA	645VA

Idle: pilot tone -36 dB, 1/2 full power: alarm tone

- DC power input: 43 VDC ~ 56 VDC
- Power consumption (DC)

model	standby mode	idle	1/8 full power	1/2 full power	full power
BTQ-VM425 BTQ-VM825	6.4W	22W	65W	175W	325W
BTQ-VM450 BTQ-VM850	6.4W	22W	95W	310W	580W

Idle: pilot tone -36 dB, 1/8 full power: speech, 1/2 full power: alarm tone

#### AUDIO CHARACTERISTICS (GENERAL)

- A/D-D/A bit resolution: 24 bit
- Sampling rate: 48 kHz
- Frequency response: 20 Hz ~ 20 kHz (±1 dB) @ 0 dBu
- SNR: > 80 dB
- THD+N: < 0.02 % @ 30 dB gain, -24 dBu (1 kHz) in
- EIN: < -86 dBra @ 0 dB gain
- Maximum input level (CD/AUX/mic): 17 dBu
- Maximum output level (line out): 17 dBu
- Crosstalk: > 70 dB @ 42 dB gain, 0 dBu (10 kHz) in

#### WATTAGE CAPACITY

- 1000W per zone/2000W (max.) per unit

#### INTERNAL POWER AMPLIFIER

- Rated output power: 250W/500W (Class-D)
- Frequency response: 50 Hz ~ 18 kHz (±3 dB) @ 0 dBu
- THD+N: < 0.1 % @ 42 dB gain, 0 dBu (1 kHz) in
- SNR: > 90 dB

#### MECHANICAL

- Dimensions (W x H x D)
  - BTQ-VM425/VM825: 437 x 88 x 396 mm (17.2 x 3.5 x 15.6 inch)
  - BTQ-VM450/VM850: 437 x 88 x 412 mm (17.2 x 3.5 x 16.2 inch)
- Weight
  - BTQ-VM425: 8.8 kg (19.4 lbs)
  - BTQ-VM450: 9.9 kg (21.8 lbs)
  - BTQ-VM825: 9.3 kg (20.5 lbs)
  - BTQ-VM850: 10.4 kg (23 lbs)
- Mounting: 19" 2U rack
- Colour: RAL 7016

#### ENVIRONMENTAL

- Operating temperature: -5 °C ~ +55 °C (+23 °F ~ +131 °F)
- Storage temperature: -40 °C ~ +70 °C (-40 °F ~ +158 °F)
- Relative humidity: 20 % to 95 %
- Air pressure: 600 to 1100 hPa
- Heat dissipation
  - BTQ-VM425/BTQ-VM825: 375 BTU/hr
  - BTQ-VM450/BTQ-VM850: 495 BTU/hr

# PA/VA Controllers

**BTQ-VM425W1 / BTQ-VM825W1**  
**BTQ-VM450W1 / BTQ-VM850W1**  
**BTQ-VM425W2 / BTQ-VM825W2**  
**BTQ-VM450W2 / BTQ-VM850W2**



## WallMount PAVA Controller

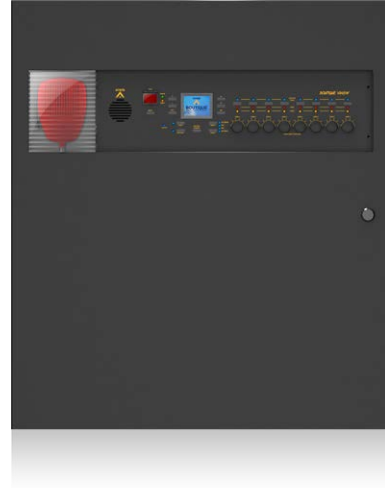
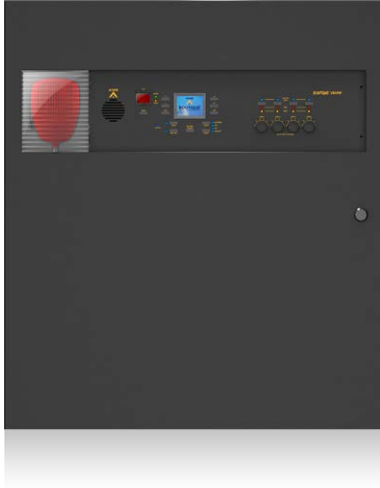

The BTQ-VM4W/VM8W is wall mount PAVA controller with integrated battery charging unit for secured battery backup and power sharing. All components contain within one heavy-duty metal housing with a lockable cover. The BTQ-VM4W/VM8W offers 4 and 8 monitored speaker zones respectively. The controller is integrated with 250W or 500W high efficiency Class-D amplifier built-in and is capable of handling 1000W speaker load per zone and 2000W max. per unit. Each controller can be networkable with up to 64 BTQ-VM4/BTQ-VM8/BTQ-VM4W/VM8W or BTQ-SG8 secondary global unit via global-net. This will then extend as little as 4 monitored A/B speaker zones to a large networked system of up to 16,384 zones. The BTQ-SG8 is linked to the controller via CAT5/6 cable (max. length 100m between units), multi-mode (2 km) and single-mode (20 km) fibre optics or even longer distance upon request.

The BTQ-VM4W has 5 monitored EVAC inputs and 4 relay control outputs, while the BTQ-VM8W has 9 monitored EVAC inputs, 8 logic control inputs and 8 relay control outputs, which can be individually programmed for specific message/input routing to all or selected channels. Moreover, the controller has 10 audio sources including two music inputs, one mic/line input, one USB input, SIP call in, one fireman microphone and two digital paging and control interfaces. Each digital paging interface provides 2CH audio inputs to simultaneously transmit bi-directional data communication in digital format. The two digital interfaces can connect up to 8 paging console or remote units for each, and be wired in a daisy chain or redundant loop. The Mic/Line input features VOX function (Voice Activation) and each input is fitted with volume controls and equalizers.

In addition, multiple volume attenuators can be installed on a monitored speaker lines without the need for a loopback cable. For branching speaker lines using the VA-EOL module, please order the "EOL driver" version of BTQ unit such as BTQ-VMD/SGD/SLD controller/secondary unit, in order to provide more power to drive the VA-EOL module.

## FEATURES

- Support as little as 4 zones to a large 16,384 zones using global network of BTQ-VM8/SG8
- Integrate with battery charging unit for secured battery backup and power sharing
- Background music and voice announcement can be distributed to different group of zones by using 2 built-in amplifiers
- Internal message storage for up to 90 minutes
- IP based music streaming and paging over LAN/WAN
- Easy integration with TerraCom, TerraManager and IP phone via SIP protocol
- Internet radio receiver built-in
- Low cost 2 channel switching amplifier architecture
- Third party control via RS232 or Ethernet
- Optional Sound Masking module - reduce the intelligibility of human speech for protecting private speech privacy

## CONTROLS AND INDICATORS

### ■ Front (4/8 zones type)

- 2.2" full colour touch screen LCD display
- 1 evacuation button
- Reset/route/select button
- Monitoring speaker
- 4/8 zone selected buttons and LEDs
- 4/8 zone EVAC LEDs
- 4/8 zone alert/page LEDs
- 4/8 BGM source status LEDs (CD/TUNER, AUX, USB, INTERNET)
- 4/8 zone volume control knobs
- 1 all-call and all-call cancel button
- Status LED (power/fault/reman MIC active/alert/MSG testing)

### ■ Back

- 2 DIP switches for VOX and phantom power
- 2 global-net port LEDs

# PA/VA Controllers

**BTQ-VM425W1 / BTQ-VM825W1**  
**BTQ-VM450W1 / BTQ-VM850W1**  
**BTQ-VM425W2 / BTQ-VM825W2**  
**BTQ-VM450W2 / BTQ-VM850W2**



## Technical Specifications

### INTERCONNECTIONS

- **Front**
  - Fireman microphone
- **Back (4/8 zones type)**
  - Mains power inlet (euroblock connector)
  - 5/9 monitored EVAC inputs
  - 4/8 speaker zone(A/B) outputs
  - 4/8 relay control outputs
  - 8 monitored logic control inputs (BTQ-VM8W)
  - 1 fault and 1 EVAC relay output
  - 2 digital interfaces for paging console and remotes
  - 1 MIC/LINE XLR 3-pin phoenix input and 2 RCA stereo input
  - 1 audio line output
  - 1 set of global-net port (optional)
  - 1 Ethernet port
  - 1 USB 2.0 for configuration backup and message/music file
  - 1 internal amp output (EU type:100V, US type:70V)
  - 24 VDC output
  - RS232 for third party control

### CERTIFICATIONS AND APPROVALS

Europe	Voice Alarm	EN 54-16 (In process)
Europe	CE/EMI	EN 55032 (In process)
Europe	CE/EMC	EN 61000-3-2 EN 61000-3-3 EN 55020 (In process)
Europe	CE/LVD	EN 60065 (In process)
USA	Safety	UL 60065 (Pending)

### ELECTRICAL

- AC power input: 100 ~ 240 VAC ± 10%, 50/60 Hz
- Power consumption (AC)

model	idle	1/2 full power	full power
BTQ-VM425/825W1 BTQ-VM425/825W2	W1/W2: 24VA	W1: 200VA W2: 380VA	W1: 390VA W2: 740VA
BTQ-VM450/850W1 BTQ-VM450/850W2	W1/W2: 24VA	W1: 380VA W2: 740VA	W1: 750VA W2: 1460VA

Idle: pilot tone -36dB, 1/2 full power: alarm tone

- DC power input: 42 VDC ~ 52 VDC

- Power consumption (DC)

model	standby mode	idle	1/8 full power	1/2 full power	full power
BTQ-VM425/825W1 BTQ-VM425/825W2	W1/W2: 6.4W	W1/W2: 22W	W1: 46W W2: 86W	W1: 180W W2: 342W	W1: 350W W2: 666W
BTQ-VM425/825W1 BTQ-VM425/825W2	W1/W2: 6.4W	W1/W2: 22W	W1: 85W W2: 168W	W1: 342W W2: 666W	W1: 675W W2: 1314W

Idle: pilot tone -36dB, 1/8 full power: speech, 1/2 full power: alarm tone

### INTEGRATED BATTERY CHARGER

- Charging
  - Voltage: 54VDC
  - Charging current: 1.5A
- Maximum output current: 30A
- Battery capacity (4 x 12V): 10 Ah to 30 Ah
- Recommended brands: Yuasa NPL Series, Power-Sonic GB Series, ABT TM Series, EnerSys VE Series, Eekta BTL Series, Long GB Series

### AUDIO CHARACTERISTICS (GENERAL)

- A/D-D/A bit resolution: 24 bit
- Sampling rate: 48 kHz
- Frequency response: 20 Hz ~ 20 kHz (±1 dB) @ 0 dBu
- SNR: > 80 dB
- THD+N: < 0.02 % @ 30 dB gain, -24 dBu (1 kHz) in
- EIN: < -86 dBra @ 0 dB gain
- Maximum input level (CD/AUX/mic): 17 dBu
- Maximum output level (line out): 17 dBu
- Crosstalk: > 70 dB @ 42 dB gain, 0 dBu (10 kHz) in

### WATTAGE CAPACITY

- BTQ-VM4/8W1: 1000W per zone/2000W (max.) per unit

### INTERNAL POWER AMPLIFIER

- Rated output power: 250W/500W (Class-D)
- Frequency response: 50 Hz ~ 18 kHz (±3 dB) @ 0 dBu
- THD+N: < 0.1 % @ 42 dB gain, 0 dBu (1 kHz) in
- SNR: > 90 dB

### MECHANICAL

- Dimensions (W x H x D)
  - BTQ-VM4W/VM8W: 653 x 735 x 130 mm ( 25.7 x 28.9 x 5.1 inch)
- Weight
  - BTQ-VM425W1: 19.3 kg (42.5 lbs)
  - BTQ-VM450W1: 20.9 kg (46.1 lbs)
  - BTQ-VM425W2: 19.6 kg (43.2 lbs)
  - BTQ-VM450W2: 21.2 kg (46.7 lbs)
  - BTQ-VM825W1: 20 kg (44.1 lbs)
  - BTQ-VM850W1: 21.6 kg (47.6 lbs)
  - BTQ-VM825W2: 20.3 kg (44.6 lbs)
  - BTQ-VM850W2: 21.9 kg (48.3 lbs)
- Mounting: Wall-mount
- Colour: RAL 7016

### ENVIRONMENTAL

- Operating temperature: -5 °C ~ +55 °C (+23 °F ~ +131 °F)
- Storage temperature: -40 °C ~ +70 °C (-40 °F ~ +158 °F)
- Relative humidity: 20 % to 95 %
- Air pressure: 600 to 1100 hPa
- Heat dissipation
  - BTQ-VM425/825W1: 478 BTU/hr
  - BTQ-VM450/850W1: 853 BTU/hr
  - BTQ-VM425/825W2: 819 BTU/hr
  - BTQ-VM450/850W2: 1570 BTU/hr

## BTQ-SG8

### PAVA Secondary Global Unit



The BTQ-SG8 PAVA secondary global unit is not only an extension unit for BTQ-VM4/8 PAVA controller but can also work independently without the BTQ-VM4/8. Up to 64 BTQ-VM4/8 or BTQ-SG8 can be networkable by full-redundancy-loop global-net via CAT5/6 cable (max. length 100m between units), multi-mode (2 km) or single-mode (20 km) fibre optic, even longer distance upon request.

The BTQ-SG8 is capable of handling 1000W speaker load per zone and 2000W max. per unit. It extends the number of input and output contacts available in the system, including 9 monitored EVAC inputs, which can be programmed to trigger either by dry contact or voltage, 8 logic control inputs and 8 relay control outputs (configured by web browser). The two digital interfaces can connect up to 16 paging consoles or remote units for each, and be wired in a daisy chain or redundant loop. In accordance with EN 54-16 requirement, all BOUTIQUE system components and peripherals are monitored from paging microphones to loudspeaker lines. The speaker lines are monitored for short, open circuit and leakage. Multiple volume attenuators can be installed on monitored speaker lines without the need for a loopback cable.

The system can easily setup from the LCD panel of BTQ-VM4/8, the advanced settings can be accessed by web browser such as volume, PEQ, audio routing, monitor and control, event and bell scheduler, paging with priority management (1~99 priority level) etc.. In addition, the BOUTIQUE contains with fully digital audio matrix and an internal message storage for up to 90 minutes and a USB interface for configuration backup.

## FEATURES

- Both background music playing and paging can be simultaneously proceeded
- Easy integration with Terracom, TerraManager and IP phone via SIP protocol
- IP based music streaming and paging over LAN/WAN
- Extremely low power consumption during standby mode (4W)
- Multiple volume attenuators can be installed on a monitored speaker lines without the need for a loopback cable. For branching speaker lines using the VA-EOL module, please order the "EOL driver" version of BTQ unit such as BTQ-VMD/SGD/SLD controller/secondary unit, in order to provide more power to drive the VA-EOL module

## DISTRIBUTED SYSTEM STRUCTURE

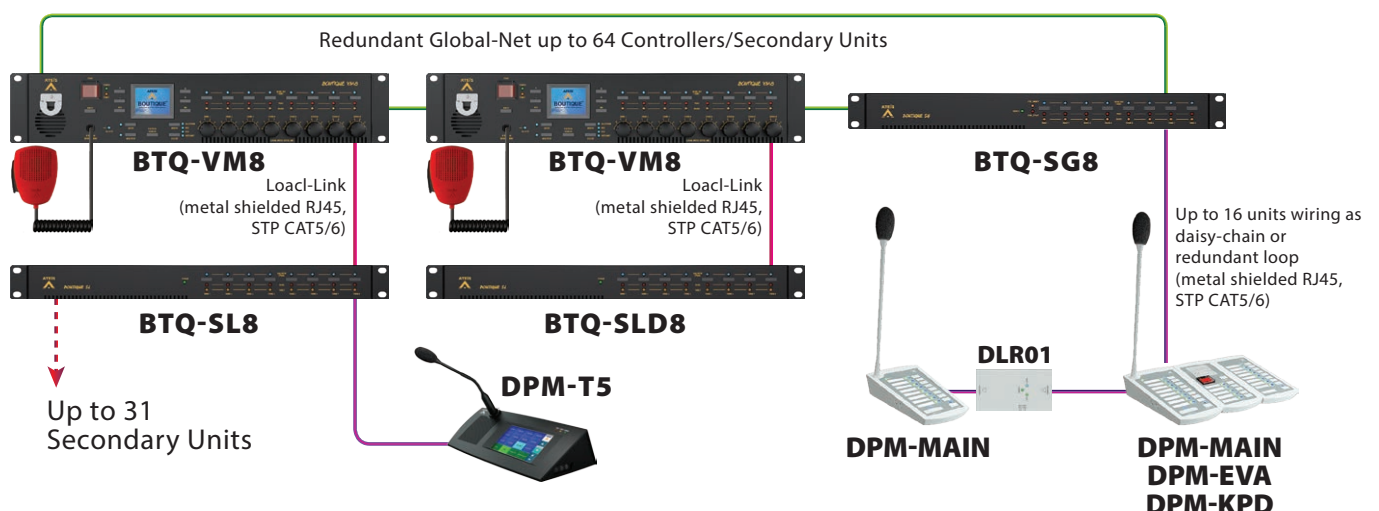

# Secondary Units



## BTQ-SG8

### Technical Specifications

#### LED INDICATORS

- **Front**
  - 8 zone selected buttons and LEDs
  - 8 zone EVAC LEDs
  - 8 zone alert page LEDs
  - Power LED
- **Back**
  - 2 global-net port LEDs

#### INTERCONNECTIONS

- **Back**
  - 24 VDC normal power input
  - 24 VDC backup power input
  - 9 monitored EVAC inputs
  - 8 speaker zone(A/B) outputs
  - 8 relay control outputs
  - 8 monitored logic control inputs
  - 2 digital ports for paging console
  - 1 fault relays & 1 EVAC relay output
  - AMP IN 1/2
  - AMP OUT 1/2 (100V)
  - 1 set of global-net port (optional)
  - 1 Ethernet port
  - USB 2.0 for configuration backup and message/music file
  - 24 VDC output
  - RS232 for third party control
  - Device ID DIP switch

#### CERTIFICATIONS AND APPROVALS

Europe	Voice Alarm	EN 54-16 (In process)
Europe	CE/EMI	EN 55032
Europe	CE/EMC	EN 55020 IEC 61000-4-2 IEC 61000-4-4
Europe	CE/LVD	EN 60065 (In process)
USA	Safety	UL 60065 (Pending)

#### ELECTRICAL

- DC power input: 21 VDC ~ 29 VDC
  - Power consumption
    - Full power: 15W
    - Standby mode: 4W

#### AUDIO CHARACTERISTICS

- A/D-D/A bit resolution: 24 bit
- Sampling rate: 48 kHz
- Frequency response: 20 Hz ~ 20 kHz (±1 dB) @ 0 dBu
- THD+N: < 0.01 % @ 0 dB gain, 4 dBu (1 kHz) in
- EIN: < -80 dBra @ 0 dB gain
- SNR: > 80 dB
- Maximum output level: 17 dBu
- Crosstalk: > 93 dB @ 0 dB gain, 0 dBu (10 kHz) in
- Output impedance: 30 ohm

#### WATTAGE CAPACITY

- 1000W per zone/2000W (max.) per unit

#### MECHANICAL

- Dimensions (W x H x D): 437 x 44 x 260 mm (17.2 x 1.7 x 10.2 inch)
- Weight: 2.6 kg (5.7 lbs)
- Mounting: 19" 1U rack
- Colour: RAL 7016

#### ENVIRONMENTAL

- Operating temperature: -5 °C ~ +55 °C (+23 °F ~ +131 °F)
- Storage temperature: -40 °C ~ +70 °C (-40 °F ~ +158 °F)
- Relative humidity: 20 % to 95 %
- Air pressure: 600 to 1100 hPa
- Heat dissipation: 51 BTU/hr



## BTQ-SL8

### PAVA Secondary Local Unit



The BTQ-SL8 is an extension unit for BTQ-VM4/8 PAVA controller. It increases the number of zones by a further 8 speaker zones. Up to 31 x BTQ-SL8 secondary units can be added per controller via a dedicated digilink local network, providing a maximum of 256 A/B zones and extends the number of input and output contacts available in the system at the same time. The BTQ-SL8 is linked to the main controller via STP CAT5/6 cable with metal shielded RJ45 connector (max. length 10M between units).

The BTQ-SL8 is capable of handling 1000W speaker load per zone and 2000W max. per unit. The BTQ-SL8 contains 9 monitored EVAC inputs, which can be programmed to trigger either by dry contact or voltage, 8 logic control inputs and 8 relay control outputs (configured by web browser). In addition, the BTQ-SL8 has a digital paging and control console interface. In accordance with EN 54-16 requirement, all BOUTIQUE system including paging microphones and loudspeaker lines are monitored. The speaker lines are monitored for short, open circuit and leakage. Multiple volume attenuators can be installed on monitored speaker lines without the need for a loopback cable.

Operational versatility is further enhanced by a dedicated ATEIS web browser such as level, PEQ, audio routing, monitor and control, event and bell scheduler for schools, priority management (1 ~ 99 priority level) etc..

## FEATURES

- Extremely low power consumption during standby mode (3.5W)
- Third party control via RS232 or Ethernet
- Multiple volume attenuators can be installed on a monitored speaker lines without the need for a loopback cable. For branching speaker lines using the VA-EOL module, please order the "EOL driver" version of BTQ unit such as BTQ-VMD/SGD/SLD controller/secondary unit, in order to provide more power to drive the VA-EOL module

## LED INDICATORS

- **Front**
  - 8 zone selected buttons and LEDs
  - 8 zone EVAC LEDs
  - 8 zone alert page LEDs
  - Power LED

## INTERCONNECTIONS

- **Back**
  - 24 VDC normal power input
  - 24 VDC backup power input
  - 9 monitored EVAC inputs
  - 8 speaker zone (A/B) outputs
  - 8 relay control outputs
  - 8 monitored logic control inputs
  - 1 fault relays & 1 EVAC relay output
  - 1 digital port for paging console
  - AMP IN 1/2
  - AMP OUT 1/2 (100V)
  - 1 set of digilink loop port (BTQ-VM4/8 to BTQ-SL8 link)
  - 24 VDC output
  - RS232 for third party control
  - Device ID DIP switch

## CERTIFICATIONS AND APPROVALS

Europe	Voice Alarm	EN 54-16 (In process)
Europe	CE/EMI	EN 55032
Europe	CE/EMC	EN 55020 IEC 61000-4-2 IEC 61000-4-4
Europe	CE/LVD	EN 60065 (In process)
USA	Safety	UL 60065 (Pending)

## ELECTRICAL

- DC power input: 21 VDC ~ 29 VDC
  - Power consumption
    - Full power: 13.5W
    - Standby mode: 3.5W

## AUDIO CHARACTERISTICS

- A/D-D/A bit resolution: 24 bit
- Sampling rate: 48 kHz
- Frequency response: 20 Hz ~ 20 kHz ( $\pm 1$  dB) @ 0 dBu
- SNR: > 80 dB
- THD+N: < 0.01 % @ 0 dB gain, 4 dBu (1 kHz) in
- EIN: < -80 dBra @ 0 dB gain
- Maximum output level: 17 dBu
- Crosstalk: > 93 dB @ 0 dB gain, 0 dBu (10 kHz) in
- Output impedance: 30 ohm

## WATTAGE CAPACITY

- 1000W per zone/2000W (max.) per unit

## MECHANICAL

- Dimensions (W x H x D): 437 x 44 x 258.5 mm (17.2 x 2 x 10.1 inch)
- Weight: 2.6 kg (5.7 lbs)
- Mounting: 19" 1U rack
- Colour: RAL 7016

## ENVIRONMENTAL

- Operating temperature: -5 °C ~ +55 °C (+23 °F ~ +131 °F)
- Storage temperature: -40 °C ~ +70 °C (-40 °F ~ +158 °F)
- Relative humidity: 20% to 95%
- Air pressure: 600 to 1100 hPa
- Heat dissipation: 48 BTU/hr

# Ordering Information

Ordering Information							
Model No.	Step 1	Step 2	Step 3	Step 4	Step 5	Step 6	Description of Model
BTQ-VM	EOL Driver	Number of Zone	250W/500W	Wall Mount/ Rack Mount	Global Net Card	Region	PAVA Controller
BTQ-SG		8	N/A	N/A		N/A	N/A
BTQ-SL					N/A		PAVA Secondary Local Unit

EOL Driver					
BTQ-VM	BTQ-SG	BTQ-SL			
✓	✓	✓			None
✓	✓	✓		D	EOL Driver
Number of Zone					
✓	–	–		4	4 Zone
✓	✓	✓		8	8 Zone
250W / 500W					
✓	–	–		25	250W
✓	–	–		50	500W
Wall Mount or Rack Mount					
✓	–	–		None	Rack Mount Type
✓	–	–		W1	Wall Mount Type(Amp x 1)
✓	–	–		W2	Wall Mount Type(Amp x 2)
Global Net Card					
✓	✓	–			None
✓	✓	–		RR	RJ45(A)-(B)
✓	✓	–		MR	Fiber Multi Mode(A)-RJ45(B)
✓	✓	–		SR	Fiber Single Mode(A)-RJ45(B)
✓	✓	–		RM	RJ45(A)-Fiber Multi Mode(B)
✓	✓	–		RS	RJ45(A)-Fiber Single Mode(B)
✓	✓	–		MM	Fiber Multi Mode(A)-(B)
✓	✓	–		SS	Fiber Single Mode(A)-(B)
Region					
✓	–	–			220~240 Vac,+48VDC Power,Amp Out 100V
✓	–	–		D	-48VDC Power Only, Amp Out 100V (for BTQ-VM 250W AMP only, N/A for BTQ-VMW1/VMW2)
✓	–	–		U	100~120 Vac,+48VDC Power,Amp Out 70V
✓	–	–		T	100~120 Vac,+48VDC Power,Amp Out 100V

## Model Examples

- BTQ-VM850: PAVA Controller,8Zone,Amp500W
- BTQ-VMD425: PAVA Controller,4Zone,Amp250W,EOL Driver
- BTQ-VMD425SR: PAVA Controller,4Zone,Amp250W,EOL Drv,Net-FS/RJ
- BTQ-VM425W2: WallMount PAVA Controller,4Zone,Amp250Wx2
- BTQ-VMD425W2: WallMount PAVA Controller,4Zone,Amp250Wx2,EOL Drv
- BTQ-VMD425W2RS: WallMount PAVA Controller,4Zone,Amp250Wx2,N-RJ/FS
- BTQ-SGD8: PAVA Secondary Global Unit,8Zone,EOL Driver
- BTQ-SLD8: PAVA Secondary Local Unit,8Zone,EOL Driver



# Ordering Information

## Network Card

<b>NET2-RR</b>	Netcard,RJ45(A)-(B),excl Ass'y Pillar
<b>NET2-MR</b>	Netcard,Fiber Multi(A)-RJ45(B),excl Ass'y Pillar
<b>NET2-SR</b>	Netcard,Fiber Single(A)-RJ45(B),excl Ass'y Pillar
<b>NET2-RM</b>	Netcard,RJ45(A)-Fiber Multi(B),excl Ass'y Pillar
<b>NET2-RS</b>	Netcard,RJ45(A)-Fiber Single(B),excl Ass'y Pillar
<b>NET2-MM</b>	Netcard,Fiber Multi(A)-(B),excl Ass'y Pillar
<b>NET2-SS</b>	Netcard,Fiber Single(A)-(B),excl Ass'y Pillar

## Copper Pillar

<b>CP-PILLAR 15</b>	Copper pillar 15 mm x 50
<b>CP-PILLAR 35</b>	Copper pillar 35 mm x 50

### Note

When purchasing the network card, please note the copper pillar is not shipped with the network card, please order copper pillar if necessary.

- To assemble the netcard to BTQ-VM, the copper pillar 35 mm x 2pcs are needed.
- To assemble the netcard to BTQ-SG8, the copper pillar 15 mm x 2pcs are needed.

# Applications



Schools/University Campus



Shopping Centres



Stadiums



Airports



Hotels



Large Office Buildings



Medical Centres

# Power Amplifiers & Battery Chargers



The BPA Bridging Power Amplifier and DPA Digital Power Amplifier are designed for public address or voice alarm system application. They are specifically developed to meet the requirements of EN 54-16 and can therefore also be used as part of fire detection and fire alarm systems.

The BCU-4830A/BCU-4875A battery chargers are designed for secured battery backup and power sharing to PA/VA system and external power amplifier.

**BPA**  
Bridging Power Amplifier



**BCU-4830A / BCU-4875A**  
Advanced Monitored Battery Charger



**DPA**  
Digital Power Amplifier



## BPA

### Bridging Power Amplifier



The BPA is a 2U 19" rack-mountable bridging power amplifier with extremely low power consumption (1.2W per channel) during standby mode; and transformer isolated for 100V, 50V, 8 ohm or 70V, 35V, 8 ohm speaker line. There are audio line inputs with a balanced XLR and phoenix connectors. The available models are listed as below:

- BPA-1240/BPA-1480/BPA-1000 (240W/480W/1000W x 1 CH)
- BPA-2060/BPA-2120/BPA-2240/BPA-2480 (60W/120W/240W/480W x 2CH)

The BPA-2060, BPA-2120, BPA-2240, BPA-2480 can be bridged (recommend) or paralleled to double the wattage for each two channels. The BPA amplifier is designed to have protection of short-to-ground or short circuit, overload and overheat. It also provides an automatic wake-up signal detection, which can automatically wake up the amplifier from standby mode when detects audio input signal (> -40 dB). The BPA amplifier has a 115 VAC or 230 VAC mains supply and a 48VDC battery backup input. The status LED on the front panel include power, fault, overload temp. and VU meter.

## FEATURES

- 2 channels BPA-2060, BPA-2120, BPA-2240, BPA-2480 can be bridged (recommend) or paralleled to double the power wattage
- Full protection circuitry: overload, short-to-ground or short circuit on speaker lines and overheat
- Extremely low power consumption during standby mode
- Input gain control
- Amplifier outputs
  - EU type: 100V, 50V, 8 ohm
  - US type: 70V, 35V, 8 ohm

## CERTIFICATIONS AND APPROVALS

Europe	Voice Alarm	EN 54-16 (Pending)
Europe	CE/EMI	EN 55032 (In process)
Europe	CE/EMC	EN 61000-3-2 EN 61000-3-3 EN 55020 (In process)
Europe	CE/LVD	EN 60065 (In process)
USA	Safety	UL 60065 (Pending)

## CONTROLS AND INDICATORS

### Front

- VU meter LEDs (-40 dB, -20 dB and 0 dB)
- Overheat LED
- Overload LED
- Power LED
- Power fault LED

### Back

- AC power socket
- Power on/off switch
- LED disable switch for EN 54-16
- 48VDC battery backup input
- Amp fault contact and on/off switch
- 1 or 2 (depend on model) channel audio output(s)
- 1 or 2 (depend on model) XLR line input(s) or euro-block terminal
- 1 or 2 (depend on model) XLR channel output(s) or euro-block terminal
- 1 or 2 (depend on model) channel input(s) gain and on/off switch
- Ground (GND) socket

## BPA

### Technical Specifications

#### ELECTRICAL

- AC power input
  - EU: 220 VAC ~ 240 VAC, 50/60 Hz
  - US: 100 VAC ~ 120 VAC, 50/60 Hz
- Power consumption (AC)

model	idle	1/2 full power	full power
<b>BPA-1240</b>	23VA	330VA	480VA
<b>BPA-1480</b>	24VA	625VA	872VA
<b>BPA-2060</b>	40VA	212VA	282VA
<b>BPA-2120</b>	30VA	345VA	458VA
<b>BPA-2240</b>	32VA	660VA	960VA
<b>BPA-2480</b>	34VA	1245VA	1745VA
<b>BPA-1000</b>	30VA	1280VA	1795VA

Idle: pilot tone -36 dB, 1/2 full power: alarm tone

- DC power input: 43 VDC ~ 56 VDC
- Power consumption (DC)

model	standby mode	idle	1/8 full power	1/2 full power	full power
<b>BPA-1240</b>	2.2W	16W	100W	274W	430W
<b>BPA-1480</b>	2.2W	17W	175W	585W	875W
<b>BPA-2060</b>	2.2W	28W	53W	154W	212W
<b>BPA-2120</b>	2.2W	21W	101W	278W	394W
<b>BPA-2240</b>	2.2W	22W	192W	548W	860W
<b>BPA-2480</b>	2.2W	23W	350W	1170W	1750W
<b>BPA-1000</b>	2.2W	20W	343W	989W	1536W

Idle: pilot tone -36 dB, 1/8 full power: speech, 1/2 full power: alarm tone

- Amplifier outputs
  - E (EU) type: 100V, 50V, 8 ohm
  - U (US) type: 70V, 35V, 8 ohm

#### AUDIO CHARACTERISTICS

- Frequency response: 50 Hz and 18 kHz ( $\pm 3$  dB)
- SNR: > 86 dB
- THD+N: < =1% @ 1 kHz
- Input impedance: 22k ohm
- Crosstalk (100V): > 80 dB @ 42 dB, 0 dBu (1 kHz) in
- Crosstalk (70V): > 80 dB @ 39 dB, 0 dBu (1 kHz) in

#### LOUDSPEAKERS OUTPUTS

model	rated output power	rated load impedance	rated load capacitance
<b>BPA-2060</b>	60W	167 ohm (100V); 82 ohm (70V) 41.6 ohm (50V); 20 ohm (35V)	30 nF (100V); 62 nF (70V)
<b>BPA-2120</b>	120W	83 ohm (100V); 41 ohm (70V) 20 ohm (50V); 10 ohm (35V)	62 nF (100V); 120 nF (70V)
<b>BPA-1240</b> <b>BPA-2240</b>	240W	41.6 ohm (100V); 20 ohm (70V) 10 ohm (50V); 5.1 ohm (35V)	120 nF (100V); 240 nF (70V)
<b>BPA-1480</b> <b>BPA-2480</b>	480W	20 ohm (100V); 10 ohm (70V) 5 ohm (50V); 2.6 ohm (35V)	240 nF (100V); 470 nF (70V)
<b>BPA-1000</b>	1000W	10 ohm (100V); 4.9 ohm (70V) 2.5 ohm (50V); 1.2 ohm (35V)	470 nF (100V); 820 nF (70V)

\* (1 min. at 40°C) (per CH)

#### MECHANICAL

- Dimensions (W x H x D)
  - BPA-1240: 426 x 88 x 295 mm (16.8 x 3.5 x 11.6 inch)
  - BPA-1480: 426 x 88 x 295 mm (16.8 x 3.5 x 11.6 inch)
  - BPA-2060: 426 x 88 x 356 mm (16.8 x 3.5 x 14 inch)
  - BPA-2120: 426 x 88 x 356 mm (16.8 x 3.5 x 14 inch)
  - BPA-2240: 426 x 88 x 376 mm (16.8 x 3.5 x 14.8 inch)
  - BPA-2480: 426 x 88 x 435 mm (16.8 x 3.5 x 17 inch)
  - BPA-1000: 426 x 88 x 390 mm (16.8 x 3.5 x 15.6 inch)
- Weight
  - BPA-1240: 10.5 kg (23.1 lbs)
  - BPA-1480: 13.5 kg (29.8 lbs)
  - BPA-2060: 13 kg (28.6 lbs)
  - BPA-2120: 13 kg (28.6 lbs)
  - BPA-2240: 16.2 kg (35.7 lbs)
  - BPA-2480: 22 kg (48.5 lbs)
  - BPA-1000: 21 kg (46.2 lbs)
- Mounting: 19" 2U rack
- Colour: RAL 7016

#### ENVIRONMENTAL

- Operating temperature: -5 °C ~ +55 °C (+23 °F ~ +131 °F)
- Storage temperature: -40 °C ~ +70 °C (-40 °F ~ +158 °F)
- Relative humidity: 20 % to 95 %
- Air pressure: 600 to 1100 hPa
- Heat dissipation
  - BPA-1240: 1512 BTU/hr
  - BPA-1480: 3044 BTU/hr
  - BPA-2060: 767 BTU/hr
  - BPA-2120: 1587 BTU/hr
  - BPA-2240: 3019 BTU/hr
  - BPA-2480: 6090 BTU/hr
  - BPA-1000: 6347 BTU/hr

#### ORDERING INFORMATION

- BPA-1240E/U/T: 240Wx1 BPamp
- BPA-1480E/U/T: 480Wx1 BPamp
- BPA-2060E/U/T: 60Wx2 BPamp
- BPA-2120E/U/T: 120Wx2 BPamp
- BPA-2240E/U/T: 240Wx2 BPamp
- BPA-2480E/U/T: 480Wx2 BPamp
- BPA-1000E/U/T: 1000Wx1 BPamp

#### Available types

E: 220-240Vac,OUT 100V/50V/8ohm  
 U: 100-120Vac,OUT 70V/35V/8ohm  
 T: 100-120Vac,OUT 100V/50V/8ohm

#### MODEL EXAMPLES

- BPA-1480E: 480Wx1 BPamp/220-240Vac,OUT 100V/50V/8ohm
- BPA-2240U: 240Wx2 BPamp/100-120Vac,OUT 70V/35V/8ohm

## DPA

### Digital Power Amplifier

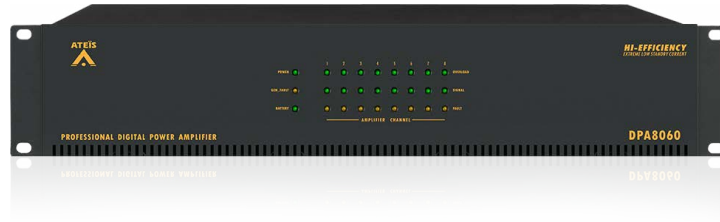

The DPA is a digital power amplifier with extremely low power consumption (0.2W per channel) during standby mode, and high amplification efficiency of 90%. A four-step DIP switch can be configured to enable/disable the function of standby mode (power-save mode) when powered by AC mains; to request the LEDs on the front panel to comply to EN 54-16; and to enable/disable the battery monitoring.

The amplifiers are powered by 100 VAC ~ 240 VAC 50/60 Hz or 48 VDC battery backup. Each model has the line inputs with individual volume gain, status LEDs (power, battery, fault, general fault, overload and signal) on the front panel, and the DPA models can bridge two channels to double the power wattage.

### FEATURES

- Class-D amplification performance and energy-efficient design
- Universal switch mode power supply with PFC (Power Factor Correction)
- Full protection circuitry against over/under AC voltage, overload, overheat, short-to-ground or short circuit on speaker lines
- Four models available: DPA8060 (60W x 8CH), DPA4125 (125W x 4CH) and DPA4250 (250W x 4CH) and DPA2500 (500W x 2CH)
- Support bridging two channels to double the power wattage
- Airflow cooling by internal speed fan (temperature controlled)
- Applicable for full scale of system applications: hotel, railway, airport, houses of worship, educational and sports facilities, club etc.

### CERTIFICATIONS AND APPROVALS

Europe	Voice Alarm	EN 54-16 (In process)
Europe	CE/EMI	EN 55032
Europe	CE/EMC	EN 61000-3-2 EN 61000-3-3 EN 55020
Europe	CE/LVD	EN 60065 (In process)
USA	Safety	UL 60065 (Pending)

### CONTROLS AND INDICATORS

#### ■ Front

- General fault LED (system failed)
- Overload LED
- Signal, fault LEDs
- Power and battery LEDs

#### ■ Rear

- AC power socket
- RS485 for firmware update
- Lamp input and spare contact input (DPA4125/4250/2500)
- General fault output and service request output
- DIP switch for Sleep-AC, EN 54-16, BAT-MNT, and one for reserved
- 2/4/8 (depend on model) channel amp outputs
- 2/4/8 (depend on model) channel inputs & volume gain
- 48 VDC battery backup input

## DPA

### Technical Specifications

#### ELECTRICAL

- AC power input: 100 VAC ~ 240 VAC, 50/60 Hz
- Power consumption (AC)

model	idle	1/2 full power	full power
DPA8060	42VA	365VA	705VA
DPA4125	34VA	340VA	650VA
DPA4250	38VA	660VA	1300VA
DPA2500	28VA	700VA	1320VA

Idle: pilot tone -36 dB, 1/2 full power: alarm tone

- DC power input: 43 VDC ~ 56 VDC
- Power consumption (DC)

model	standby mode	idle	1/8 full power	1/2 full power	full power
DPA8060	2W	35W	92W	330W	635W
DPA4125	0.7W	30W	85W	305W	585W
DPA4250	0.7W	34W	165W	595W	1170W
DPA2500	0.7W	25W	175W	630W	1180W

Idle: pilot tone -36 dB, 1/8 full power: speech, 1/2 full power: alarm tone

- Amplifier outputs
  - EU type: 100V, 50V, 4 ohm
  - US type: 70V, 35V, 4 ohm

#### AUDIO CHARACTERISTICS

- Frequency response: 50 ~ 20 kHz ( $\pm 3$  dB) @ 0 dBu
- SNR: > 90 dB
- THD+N: < 0.1% @ 1 kHz
- Maximum input level: 0 dBu
- Input impedance
  - DPA2500: 10k ohm
  - DPA8060/DPA4125/DPA4250: 12k ohm
- Crosstalk: > 70 dB @ 0 dBu gain

#### LOUDSPEAKERS OUTPUTS

model	rated output power	rated load impedance	rated load capacitance
DPA8060	60W	167 ohm (100V); 82 ohm (70V) 41.6 ohm (50V); 20 ohm (35V)	30 nF (100V); 62 nF (70V)
DPA4125	125W	80 ohm (100V); 40 ohm (70V) 20 ohm (50V); 10 ohm (35V)	62 nF (100V); 120 nF (70V)
DPA4250	250W	40 ohm (100V); 20 ohm (70V) 10 ohm (50V); 5 ohm (35V)	240 nF (100V); 470 nF (70V)
DPA2500	500W	20 ohm (100V); 10 ohm (70V) 5 ohm (50V); 2.5 ohm (35V)	120 nF (100V); 240 nF (70V)

\* (1 min. at 40°C) (per CH)

#### MECHANICAL

- Dimensions (W x H x D)
  - DPA8060: 437 x 88 x 400 mm (17.2 x 3.5 x 15.7 inch)
  - DPA4125: 437 x 88 x 370 mm (17.2 x 3.5 x 14.6 inch)
  - DPA4250: 437 x 88 x 387 mm (17.2 x 3.5 x 15.2 inch)
  - DPA2500: 437 x 88 x 387 mm (17.2 x 3.5 x 15.2 inch)
- Weight
  - DPA8060: 14.8 kg (32.6 lbs)
  - DPA4125: 14.5 kg (32 lbs)
  - DPA4250: 14.5 kg (32 lbs)
  - DPA2500: 16 kg (35.2 lbs)
- Mounting: 19" 2U rack
- Colour: RAL 7016

#### ENVIRONMENTAL

- Operating temperature: -5 °C ~ +55 °C (+23 °F ~ +131 °F)
- Storage temperature: -40 °C ~ +70 °C (-40 °F ~ +158 °F)
- Relative humidity: 20 % to 95 %
- Air pressure: 600 to 1100 hPa
- Heat dissipation
  - DPA8060: 767 BTU/hr
  - DPA4125: 512 BTU/hr
  - DPA4250: 1024 BTU/hr
  - DPA2500: 1092 BTU/hr

#### ORDERING INFORMATION

- DPA8060E: 60Wx8 DPamp/100-240Vac,OUT 100V/50V/4ohm
- DPA8060U: 60Wx8 DPamp/100-240Vac,OUT 70V/35V/4ohm
- DPA4125E: 125Wx4 DPamp/100-240Vac,OUT 100V/50V/4ohm
- DPA4125U: 125Wx4 DPamp/100-240Vac,OUT 70V/35V/4ohm
- DPA4250E: 250Wx4 DPamp/100-240Vac,OUT 100V/50V/4ohm
- DPA4250U: 250Wx4 DPamp/100-240Vac,OUT 70V/35V/4ohm
- DPA2500E: 500Wx2 DPamp/100-240Vac,OUT 100V/50V/4ohm
- DPA2500U: 500Wx2 DPamp/100-240Vac,OUT 70V/35V/4ohm

## BCU-4830A / BCU-4875A

### Advanced Monitored Battery Charger

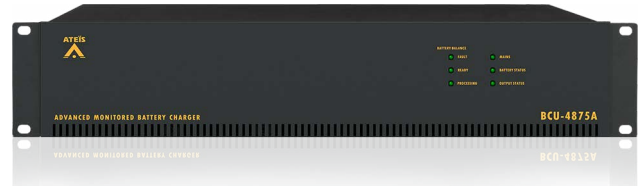

The BCU-4830A/BCU-4875A battery chargers (48 VDC) are designed for secured battery backup and power sharing to PA/VA system. The microprocessor-based design makes the charging process be programmed and optimized by sensing the battery status and temperature. With Battery Balance function, the capacity utilization of the battery cells can be maximized and increases the longevity as well.

The two (BCU-4830A)/six (BCU-4875A) 48V outputs provide the controllers or power amplifiers with a maximum current 30A (BCU-4830A)/75A (BCU-4875A) per unit, 20A per output. And three 24V outputs provide auxiliary or remote units with a maximum current 8A per unit, 3A per output. The maximum charging current of BCU-4830A is 3A and 6A for BCU-4875A. In addition, four fault contact outputs (GENERAL/MAINS/BATTERY/OUTPUT) are equipped for remote status monitoring, including the AC mains power fault, bad battery, battery voltage is too high or too low and battery is not present.

#### CONTROLS AND INDICATORS

##### ■ Front

- Mains LED, battery status LED, output status LED
- Battery balance LEDs: fault, ready, processing

##### ■ Back

- AC power cord socket
- Battery terminal
- Monitor DIP switch
- Temperature sensor
- Battery balance terminal
- Contacts outputs (general fault, mains status, battery status, output status)
- 2 mains output terminals (BCU-4830A)
- 6 mains output terminals (BCU-4875A)
- 3 auxiliary output terminals (24V)

#### AC POWER INPUT

- Voltage: 100 VAC ~ 240 VAC, 50/60 Hz

#### POWER CONSUMPTION (AC)

model	standby mode	full power
<b>BCU-4830A</b>	5W	220W
<b>BCU-4875A</b>	8W	410W

#### POWER CONSUMPTION (DISCHARGING)

model	standby mode	full power
<b>BCU-4830A</b>	4W	1440W
<b>BCU-4875A</b>	6.5W	3600W

#### CHARGING

- Voltage: 48 VDC
- Maximum charging current
  - BCU-4830A: 3A
  - BCU-4875A: 6A

#### BATTERIES

- Battery capacity (4 x 12V)
  - BCU-4830A: 10 Ah to 65 Ah
  - BCU-4875A: 26 Ah to 120 Ah

#### CERTIFICATIONS AND APPROVALS

Europe	Voice Alarm	EN 54-4 (In process)
Europe	CE/EMI	EN 55032 (In process)
Europe	CE/EMC	EN 61000-4-2 (ESD) (In process)
Europe	CE/LVD	EN 60065 (In process)
USA	Safety	UL 60065 (Pending)

#### MECHANICAL

- Dimensions (W x H x D)
  - BCU-4830A: 437 x 88 x 270 mm (17.2 x 3.5 x 10.6 inch)
  - BCU-4875A: 437 x 88 x 270 mm (17.2 x 3.5 x 10.6 inch)
- Weight
  - BCU-4830A: 5.5 kg (12.1 lbs)
  - BCU-4875A: 6 kg (13 lbs)
- Mounting: 19" 2U rack
- Colour: RAL 7016

#### ENVIRONMENTAL

- Operating temperature: -5 °C ~ +55 °C (+23 °F ~ +131 °F)
- Storage temperature: -40 °C ~ +70 °C (-40 °F ~ +158 °F)
- Relative humidity: 20 % to 95 %
- Air pressure: 600 to 1100 hPa
- Heat dissipation
  - BCU-4830A: 102 BTU/hr
  - BCU-4875A: 205 BTU/hr

#### ORDERING INFORMATION

- BCU-4830A: Advanced Monitored Battery Charger 3amp/30amp
- BCU-4875A: Advanced Monitored Battery Charger 6amp/75amp

# Digital Paging Consoles



**DPM-MAIN** - Digital Redundant Loop Paging Microphone-Main

**DPM-EVA** - EVAC Unit with Speaker and Extra Buttons

**DPM-KPD** - Additional 8+1 Microphone Keypad



**DPM-T5**

5" TouchPanel Paging Mic Console



**DPM-T5F**

5" TouchPanel Paging Mic Console  
w/EVAC Button



**CD-8DF**

WallMount Paging Mic Console,  
8 keys, EVAC Button



**CD-16DF**

WallMount Paging Mic Console,  
16 keys, EVAC Button



**CD-T5DF**

WallMount 5" TouchPanel Paging  
Console, EVAC



# Digital Paging Consoles



## DPM-MAIN / DPM-EVA / DPM-KPD

### Digital Redundant Loop Paging Microphone



#### DPM-MAIN

Digital Redundant Loop Paging Microphone-Main

#### DPM-EVA

EVAC Unit with Speaker and Extra Buttons

#### DPM-KPD

Additional 8+1 Microphone Keypad

The DPM consists of three units: DPM-MAIN, DPM-EVA and DPM-KPD. The DPM-MAIN is a digital redundant loop paging microphone which provides 8 programmable buttons and a talk button. The DPM-KPD is an additional 8+1 microphone keypad used to expand the keys of DPM-MAIN, and the DPM-EVA is an EVAC unit with monitoring speaker and extra 5 programmable buttons.

Up to 16 paging consoles can be connected to BTQ-SL8, and 32 on BTQ-VM4/VM8/SG8; the wiring can be daisy-chain or in redundant loop. The DPM-MAIN can attach 1 DPM-EVA and 14 DPM-KPD or 1 DPM-MAIN can attach 15 DPM-KPD by the flat cable (max. 128 keys). The maximum communication cable length between the BTQ-VM/SL8/SG8 and DPM-MAIN is 250M (820 ft.) via STP CAT5/6 cable with metal shielded RJ45 connector. The distance of cable length will directly affect the quantity and power requirement of DPM-MAIN unit\*.

The microphone capsule of DPM-MAIN is fully monitored and has Auto Gain Control (AGC) function to increase/decrease the level of microphone automatically. The programmable buttons can be set to act as single or group zone selection, event triggering, recording, message playing button etc.. All the settings are configured via web browser. The Talk button can be programmed for PTT (push-to-talk) or latching mode as well. The DPM is also an eco-friendly product with extremely low power consumption (< 1W) during standby mode.

\* The distance of cable length will directly affect the quantity and power requirement of DPM-MAIN unit.

1. The longer the cable is, the less power the BTQ-VM/SL8/SG8 can supply to the remote units.
2. The more the remote units have cascaded in daisy-chain/redundant loop, the less power the BTQ-VM/SL8/SG8 can supply to the remote units.

Therefore, if the cable length between the BTQ-VM and DPM-MAIN is within 250m, the DPM-MAIN can be powered by BTQ-VM. If the cable length is beyond 250m, please connect the DLR01 digital loop repeater and PSU65-27 27VDC power adapter, ensuring the control signal and power supply of DPM-MAIN units are enough. To know the max. distance between BTQ-VM/SL8/SG8 and DPM-MAIN unit(s) and the max. distance which the DPM-MAIN can be powered by DLR01 unit, please see BOUTIQUE user manual for details.

## CONNECTION DIAGRAM

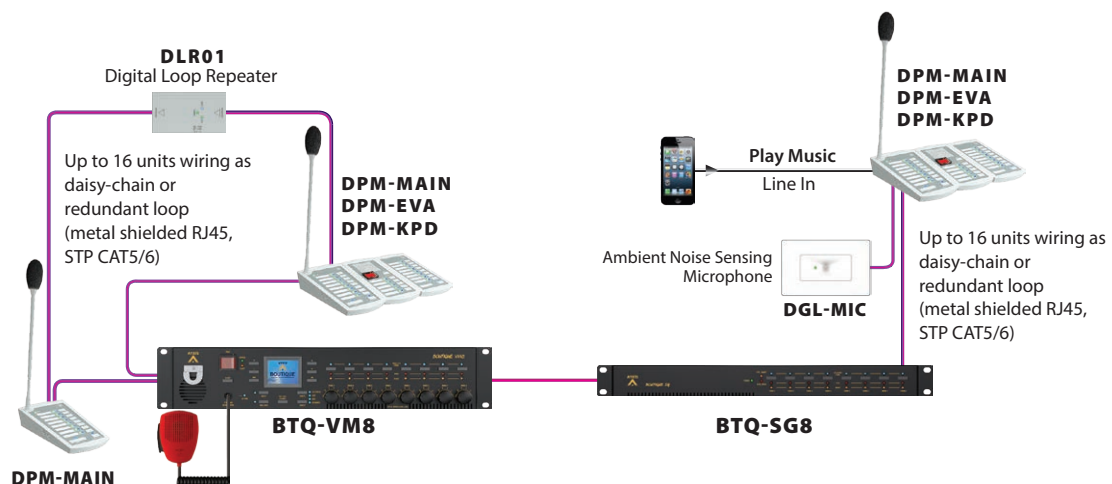

## DPM-MAIN / DPM-EVA / DPM-KPD

### Technical Specifications

#### CONTROLS AND INDICATORS

- DPM-MAIN
  - Talk button (push-to-talk or latching mode)
  - 8 programmable buttons with individual status LED
  - Gooseneck paging microphone
  - Status LED (power, busy hold, talk, all-call and release all-call)
  - All/release button (select/deselect all zones)
  - Speaker & mic volume control
- DPM-KPD
  - 8 programmable buttons with individual status LED
  - Status LED (power, busy hold, talk, all-call and release all-call)
  - All/release button
- DPM-EVA
  - 5 programmable buttons with individual status LED
  - Monitored loudspeaker
  - Status LED (busy hold and fault)
  - EVAC button and reset button

#### INTERCONNECTIONS

- DPM-MAIN
  - 2 remote ports (metal shielded RJ45 connector, STP CAT5/6)
  - 2 x 3.5 mm mini-jack for earphone and microphone
- DPM-MAIN/DPM-EVA/DPM-KPD
  - Flat cable for the connection of DPM-MAIN/DPM-EVA/DPM-KPD

#### CERTIFICATIONS AND APPROVALS

Europe	Voice Alarm	EN 54-16 (In process)
Europe	CE/EMI	EN 55032
Europe	CE/EMC	EN 55020 IEC 61000-4-2 (In process)
Europe	CE/LVD	EN 60065 (In process)
USA	Safety	UL 60065 (Pending)

#### ELECTRICAL

- DC power input: 21 VDC ~ 29 VDC
  - Power consumption: full power/standby mode
    - DPM-MAIN: 1.8W/1W
    - DPM-EVA: 3.7W/0.3W
    - DPM-KPD: 1W/0.5W
- \* The distance of cable length will directly affect the quantity and power requirement of DPM-MAIN unit.
1. The longer the cable is, the less power the BTQ-VM/SL8/SG8 can supply to the remote units.
  2. The more the remote units has cascaded in daisy-chain/redundant loop, the less power the BTQ-VM/SL8/SG8 can supply to the remote units.

Therefore, if the cable length between the BTQ-VM and DPM-MAIN is within 250m, the DPM-MAIN can be powered by BTQ-VM. If the cable length is beyond 250m, please connect the DLR01 digital loop repeater and PSU65-27 27VDC power adapter, ensuring the control signal and power supply of DPM-MAIN units are enough. To know the max. distance between BTQ-VM/SL8/SG8 and DPM-MAIN unit(s) and the max. distance which the DPM-MAIN can be powered by DLR01 unit, please see BOUTIQUE user manual for details.

#### AUDIO CHARACTERISTICS (GENERAL)

- A/D-D/A bit resolution: 24 bit
- Sampling rate: 48 kHz
- Frequency response: 20 Hz ~ 20 kHz ( $\pm 1$  dB) @ 0 dBu
- SNR: > 85 dB
- THD+N: < 0.2 % @ 26 dB gain, -26 dBu (1 kHz) in
- Max. speaker SPL: 90 dBA @ 3m
- Max. mic SPL: 105 dBA @ 3m
- Capsule type: Electret condenser
- Capsule Sensitivity: -15 dBu/Pa @ 1 kHz
- Capsule directivity: Uni-directional
- Polar pattern: Cardioid

#### MECHANICAL

- Dimensions (W x H x D)
  - DPM-MAIN base: 108 x 46 x 200 mm (4.3 x 1.8 x 7.9 inch)
  - DPM-MAIN with microphone: 108 x 319 x 200 mm (4.3 x 12.6 x 7.9 inch)
  - DPM-KPD/DPM-EVA: 96 x 46 x 200 mm (3.8 x 1.8 x 7.9 inch)
- Weight
  - DPM-MAIN/DPM-EVA/DPM-KPD: 0.5 kg (1.1 lbs)
- Colour: RAL 7035

#### ENVIRONMENTAL

- Operating temperature: -5 °C ~ +55 °C (+23 °F ~ +131 °F)
- Storage temperature: -40 °C ~ +70 °C (-40 °F ~ +158 °F)
- Relative humidity: 20 % to 95 %
- Air pressure: 600 to 1100 hPa
- Heat dissipation
  - DPM-MAIN: 0.87 BTU/hr
  - DPM-EVA: 0.76 BTU/hr
  - DPM-KPD: 0.02 BTU/hr

#### ORDERING INFORMATION

- DPM-MAIN: Digital Redundant Loop Paging Microphone-Main
- DPM-KPD: Additional 8+1 Microphone Keypad
- DPM-EVA: EVAC Unit with Speaker and Extra Buttons

# Digital Paging Consoles



## DPM-T5 / DPM-T5F

### 5" Touchpanel Paging Mic Console



**DPM-T5**  
5" TouchPanel Paging Mic Console



**DPM-T5F**  
5" TouchPanel Paging Mic Console  
w/EVAC Button

The DPM-T5/DPM-T5F 5" touchpanel paging mic console provides call-paging, message broadcasting, event triggering, recording, message routing, message play, level control etc.. Up to 16 paging consoles can be connected to BTQ-SL8, and 32 on BTQ-VM4/VM8/SG8; the wiring can be daisy-chain or in redundant loop. The maximum communication cable length between the BTQ-VM/SL8/SG8 and DPM-T5/DPM-T5F is 250M (820 ft.) via STP CAT5/6 cable with shielded RJ45 connector. The distance of cable length will directly affect the quantity and power requirement of DPM-T5/DPM-T5F unit\*.

The DPM-T5 is equipped with a 3.5mm phone jack mic input and a speaker output for the connection of external headset. Both DPM-T5 and DPM-T5F have a mini-USB port for PC/Laptop connection, making the far-end device using Skype, QQ, WhatsApp etc. be paged to BOUTIQUE system. In addition, the DPM-T5F has an evacuation button. The backlit full colour touch screen panel is designed for user-friendly operation and offers multiple pages for the selection of a zone/a group of zones.

### FEATURES

- Display the status of fault, zone, monitoring
- Message playing, zone selection, level adjustment, event triggering
- AGC (Automatic gain control) function
- Support multiple pages for assigned zones/events
- Monitoring loudspeaker

### CONTROLS AND INDICATORS

- 5" full colour touch screen, 800 x 480 pixels
- 3 status LED display the power, fault and evac status
- Evacuation button (DPM-T5F only)

### INTERCONNECTIONS

- Front: Gooseneck microphone
- Rear: 2 remote ports (metal shielded RJ45 connector, STP CAT5/6)
- Side
  - 1 x Mini-USB to connect to PC/Laptop
  - 2 x 3.5 mm mini-jack for earphone and microphone (DPM-T5 only)

### CERTIFICATIONS AND APPROVALS

Europe	Voice Alarm	EN 54-16 (In process)
Europe	CE/EMI	EN 55032 (In process)
Europe	CE/EMC	EN 61000-3-2 EN 61000-3-3 EN 55020 (In process)
Europe	CE/LVD	EN 60065 (In process)
USA	Safety	UL 60065 (Pending)

### AUDIO CHARACTERISTICS (GENERAL)

- A/D-D/A bit resolution: 24 bit
- Sampling rate: 48 kHz
- Frequency response: 20 Hz ~ 20 kHz ( $\pm 1$  dB) @ 0 dBu
- SNR: > 85 dB
- THD+N: < 0.2 % @ 26 dB gain, -26 dBu (1 kHz) in
- Max. speaker SPL: 90 dBA @ 3m
- Max. mic SPL: 105 dBA @ 3m
- Capsule type: Electret condenser
- Capsule Sensitivity: -15 dBu/Pa @ 1 kHz
- Capsule directivity: Uni-directional
- Polar pattern: Cardioid

### ELECTRICAL

- DC power input: 21 VDC ~ 29 VDC
- Power consumption
  - Full power: 15W
  - Standby mode: 1W
- \* The distance of cable length will directly affect the quantity and power requirement of DPM-T5/DPM-T5F unit.
  1. The longer the cable is, the less power the BTQ-VM/SL8/SG8 can supply to the remote units.
  2. The more the remote units has cascaded in daisy-chain/redundant loop, the less power the BTQ-VM/SL8/SG8 can supply to the remote units.

Therefore, if the cable length between the BTQ-VM and DPM-T5/DPM-T5F is within 125m, the DPM-T5/DPM-T5F can be powered by BTQ-VM. If the cable length is beyond 125m, please connect the DLR01 digital loop repeater and PSU65-27 27VDC power adapter, ensuring the control signal and power supply of DPM-T5/DPM-T5F units are enough. To know the max. distance between BTQ-VM and DPM-T5/DPM-T5F unit(s) and the max. distance which the DPM-T5/DPM-T5F can be powered by DLR01 unit, please see BOUTIQUE user manual for details.

### MECHANICAL

- Dimensions (W x H x D)
  - DPM-T5 base: 284 x 80 x 174 mm (11.2 x 3.1 x 6.9 inch)
  - DPM-T5F base: 320 x 174 x 170 mm (13 x 6.9 x 6.7 inch)
  - DPM-T5 with microphone: 284 x 332 x 174 mm (11.2 x 13 x 6.9 inch)
  - DPM-T5F with microphone: 320 x 332 x 174 mm (13 x 13 x 6.9 inch)
- Weight
  - DPM-T5: 1.1 kg (2.4 lbs)
  - DPM-T5F: 1.5 kg (3.3 lbs)
- Colour: RAL 7016

### ENVIRONMENTAL

- Operating temperature: -5 °C ~ +55 °C (+23 °F ~ +131 °F)
- Storage temperature: -40 °C ~ +70 °C (-40 °F ~ +158 °F)
- Relative humidity: 20 % to 95 %
- Air pressure: 600 to 1100 hPa
- Heat dissipation: 4.3 BTU/hr

### ORDERING INFORMATION

- DPM-T5: 5" TouchPanel Paging Mic Console
- DPM-T5F: 5" TouchPanel Paging Mic Console w/EVAC Button

# Digital Paging Consoles



## CD-8DF / CD-16DF

### WallMount Paging Mic Console, 8/16 keys, EVAC Button



The CD-8DF/CD-16DF wall mount paging mic console with 8/16 keys and EVAC button is designed with an encased IP30 heavy-duty metal box with a lockable cover. The 8/16 programmable zone buttons can set to act as single or group zone selection, event triggering, recording, message playing button etc.. All the settings are configured via web browser. The talk button can also be programmed for PTT (push-to-talk) or latching mode. In addition, it is equipped with a fireman microphone and an evacuation button.

Up to 16 paging consoles can be connected to BTQ-SL8, and 32 on BTQ-VM4/VM8/SG8; the wiring can be daisy-chain or in redundant loop. The maximum communication cable length between the BTQ-VM/SL8/SG8 and CD-8DF/CD-16DF is 250M (820 ft.) via STP CAT5/6 cable with shielded RJ45 connector\*. The CD-8DF/CD-16DF is also an eco-friendly product with extremely low power consumption (<1.5W) during standby mode.

### FEATURES

- Wall-mount metal enclosure with lockable cover
- Up to 8 paging consoles can be connected to BTQ-SL8, and 16 on BTQ-VM4/VM8/SG8; the wiring can be daisy-chain or in redundant loop
- AGC (Automatic gain control) function

### CONTROLS AND INDICATORS

- Fireman microphone (push-to-talk)
- Monitoring loudspeaker
- 8/16 programmable buttons with individual status LED
- Evacuation button
- Talk button (press-to-talk or latch mode)
- Select/cancel all/reset evacuation button
- Status LED (power/busy/hold/press to talk/select cancel all)

### INTERCONNECTIONS

- Rear: 2 remote ports (metal shielded RJ45 connector, STP CAT5/6)

### CERTIFICATIONS AND APPROVALS

Europe	Voice Alarm	EN 54-16 (In process)
Europe	CE/EMI	EN 55032
Europe	CE/EMC	EN 55020 IEC 61000-4-2
Europe	CE/LVD	EN 60065 (In process)
USA	Safety	UL 60065 (Pending)

### AUDIO CHARACTERISTICS

- A/D-D/A bit resolution: 24 bit
- Sampling rate: 48 kHz
- Frequency response: 20 Hz ~ 20 kHz (±1 dB) @ 0 dBu
- SNR: > 85 dB
- THD+N: < 0.2 % @ 26 dB gain, -26 dBu (1 kHz) in
- Max. speaker SPL: 90 dBA @ 3m
- Max. mic SPL: 105 dBA @ 3m

### ELECTRICAL

- DC power input: 21 VDC ~ 29 VDC
- Power consumption: CD-8DF/CD-16DF
  - Full power: 5W/6W
  - Standby mode: 1W/1.5W
- \* The distance of cable length will directly affect the quantity and power requirement of CD-8DF/CD-16DF unit.
  1. The longer the cable is, the less power the BTQ-VM/SL8/SG8 can supply to the remote units.
  2. The more the remote units has cascaded in daisy-chain/redundant loop, the less power the BTQ-VM/SL8/SG8 can supply to the remote units..

Therefore, if the cable length between the BTQ-VM and CD-8DF/CD-16DF is within 250m, the CD-8DF/CD-16DF can be powered by BTQ-VM. If the cable length is beyond 250m, please connect the DLR01 digital loop repeater and PSU65-27 27VDC power adapter, ensuring the control signal and power supply of CD-8DF/CD-16DF units are enough. To know the max. distance between BTQ-VM/SL8/SG8 and CD-8DF/CD-16DF unit(s) and the max. distance which the CD-8DF/CD-16DF can be powered by DLR01 unit, please see BOUTIQUE user manual for details.

### MECHANICAL

- Dimensions (W x H x D)
  - CD-8DF: 329 x 187 x 101 mm (13 x 7.4 x 4 inch)
  - CD-16DF: 349 x 241 x 101 mm (13.7 x 9.5 x 4 inch)
- Weight
  - CD-8DF: 3.4 kg (7.5 lbs)
  - CD-16DF: 4.1 kg (9 lbs)
- Colour: RAL 7016

### ENVIRONMENTAL

- Operating temperature: -5 °C ~ +55 °C (+23 °F ~ +131 °F)
- Storage temperature: -40 °C ~ +70 °C (-40 °F ~ +158 °F)
- Relative humidity: 20 % to 95 %
- Air pressure: 600 to 1100 hPa
- Heat dissipation
  - CD-8DF: 0.87 BTU/hr
  - CD-16DF: 0.89 BTU/hr

### ORDERING INFORMATION

- CD-8DF: WallMount Paging Mic Console, 8 keys, EVAC Button
- CD-16DF: WallMount Paging Mic Console, 16 keys, EVAC Button

# Digital Paging Consoles



## CD-T5DF

### WallMount 5" TouchPanel Paging Console, EVAC



The CD-T5DF wall mount paging console comes with a LCD touch screen panel, fireman microphone and evacuation button. It is designed with an encased IP30 heavy-duty metal box with a lockable cover. The 5" TFT touch screen panel provides call-paging, message broadcasting, event triggering, recording, message routing, message play, level control etc..

All paging functions and parameters for site operation such as naming zone buttons, zone group buttons, zone paging, pre/post chime settings can be pre-programmed via web browser. Moreover, several user levels with password protection make the CD-T5DF a versatile console that fits well in a commercial shopping centre or an industrial high-security facility.

Up to 16 paging consoles can be connected to BTQ-SL8, and 32 on BTQ-VM4/VM8/SG8; the wiring can be daisy-chain or in redundant loop. The maximum communication cable length between the BTQ-VM/SL8/SG8 and CD-T5DF is 250M (820 ft.) via STP CAT5/6 cable with shielded RJ45 connector\*. The CD-T5DF is also an eco-friendly product with extremely low power consumption (1W) during standby mode.

### FEATURES

- Wall-mount metal enclosure with lockable cover
- Up to 8 paging consoles can be connected to BTQ-SL8, and 16 on BTQ-VM4/VM8/SG8; the wiring can be daisy-chain or in redundant loop
- Support multiple pages for assigned zones/events on LCD panel
- AGC (Automatic gain control) function

### CONTROLS AND INDICATORS

- 5" full colour touch screen, 800 x 480 pixels
- Fireman microphone (push-to-talk)
- Monitoring loudspeaker
- Evacuation button
- 3 status LED (evac/power/fault)

### INTERCONNECTIONS

- Rear: 2 remote ports (metal shielded RJ45 connector, STP CAT5/6)

### CERTIFICATIONS AND APPROVALS

Europe	Voice Alarm	EN 54-16 (In process)
Europe	CE/EMI	EN 55032 (In process)
Europe	CE/EMC	EN 61000-3-2 EN 61000-3-3 EN 55020 (In process)
Europe	CE/LVD	EN 60065 (In process)
USA	Safety	UL 60065 (Pending)

### ELECTRICAL

- DC power input: 21 VDC ~ 29 VDC
- Power consumption
  - Full power: 15W
  - Standby mode: 1W
- \* The distance of cable length will directly affect the quantity and power requirement of CD-T5DF unit.
  1. The longer the cable is, the less power the BTQ-VM/SL8/SG8 can supply to the remote units.
  2. The more the remote units has cascaded in daisy-chain/redundant loop, the less power the BTQ-VM/SL8/SG8 can supply to the remote units.

Therefore, if the cable length between the BTQ-VM and CD-T5DF is within 125m, the CD-T5DF can be powered by BTQ-VM. If the cable length is beyond 125m, please connect the DLR01 digital loop repeater and PSU65-27 27VDC power adapter, ensuring the control signal and power supply of CD-T5DF units are enough. To know the max. distance between BTQ-VM/SL8/SG8 and CD-T5DF unit(s) and the max. distance which the CD-T5DF can be powered by DLR01 unit, please see BOUTIQUE user manual for details.

### AUDIO CHARACTERISTICS (GENERAL)

- A/D-D/A bit resolution: 24 bit
- Sampling rate: 48 kHz
- Frequency response: 20 Hz ~ 20 kHz ( $\pm 1$  dB) @ 0 dBu
- SNR: > 85 dB
- THD+N: < 0.2 % @ 26 dB gain, -26 dBu (1 kHz) in
- Max. speaker SPL: 90 dBA @ 3m
- Max. mic SPL: 105 dBA @ 3m

### MECHANICAL

- Dimensions (W x H x D): 339 x 208 x 101 mm (13.3 x 8.2 x 4 inch)
- Weight: 3.4 kg (7.5 lbs)
- Colour: RAL 7016

### ENVIRONMENTAL

- Operating temperature: -5 °C ~ +55 °C (+23 °F ~ +131 °F)
- Storage temperature: -40 °C ~ +70 °C (-40 °F ~ +158 °F)
- Relative humidity: 20 % to 95 %
- Air pressure: 600 to 1100 hPa
- Heat dissipation: 4.3 BTU/hr

### ORDERING INFORMATION

- CD-T5DF: WallMount 5" TouchPanel Paging Console, EVAC

# BOUTIQUE™

## Accessories

### DNM2-ETH

Digital Ambient Noise Sensing Mic, Ethernet



Pendant Type

### DGL-MIC

Flush/Ceiling Mount Microphone



Flush Mount Type

### VAT

Volume Attenuator



EU Type



US Type

### DLR01

Digital Loop Repeater



### VA-DLC-100 / VA-DLC-70

Dummy Load Capacitor Module

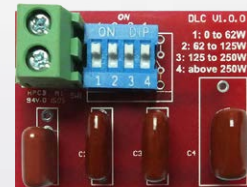

### VA-EOL

End of SP-line Module  
for Multi-branch/3-wire



### SL-SENSOR2 / SL-SENSOR4

3 Wire Speaker Line Short Sensor



### BLKR-60 / BLKR-200

20kHz Signal Blocker



## DNM2-ETH / DGL-MIC

### Ambient Noise Sensing Mic



Pendant Type  
via Ethernet



Flush Mount Type  
via remote port

The DNM2-ETH/DGL-MIC is a ambient noise sensing microphone, offering precise detection of the background noise and automatically adjusts the output level of loudspeaker to achieve the optimal intelligibility of sound. It features high sensitivity and omni-directional pick up pattern. There are two kinds of DNM component which can be configured to adjusted the speaker level on BOUTIQUE web browser, one is static, and the other is dynamic.

One DGL-MIC can be connected to the remote console port of BTQ-VM4/VM8 or connect one DGL-MIC at the end of daisy-chain remote bus. The DNM2-ETH is powered by PoE (Power over Ethernet) via CAT5/6 cable (100m max.). Up to 8 DNM2-ETH devices can connect to each BOUTIQUE local network, and up to 256 DNM2-ETH devices can connect to a BOUTIQUE system (8 DNM2-ETH x 31 local networks).

#### ELECTRICAL

- DNM2-ETH: Powered by PoE (Conform IEEE 802.3af)
- DGL-MIC
  - DC power input: 21 VDC ~ 29VDC
  - Max. power consumption: 2.4W

#### AUDIO CHARACTERISTICS

- Capsule type: Electret condenser
- Capsule directivity: Omni-directional
- Ambient noise measurement range: 55 dBA ~ 88 dBA
- Deviation of mic pickup directivity: 0 ~ -1.5 dB ( $\pm 30^\circ$ )  
0 ~ -3.7 dB ( $\pm 45^\circ$ )  
0 ~ -5.3 dB ( $\pm 90^\circ$ )

#### NETWORK

- DNM2-ETH: CAT5/6 cable with RJ45 connector via Ethernet port (max. 100M)
- DGL-MIC: STP CAT5/6 cable with metal shielded RJ45 connector via remote port (max. 250M)

#### MECHANICAL

- Dimensions
  - DNM2-ETH (Diameter x H): 105 mm x 130 mm (4.1 x 5.1 inch)
  - DGL-MIC (W x H x D): 110 x 70 x 52 mm (4.3 x 2.6 x 2 inch)
- Weight
  - DNM2-ETH: 0.13 kg (0.28 lbs)
  - DGL-MIC: 0.1 kg (0.22 lbs)
- Colour
  - DNM2-ETH: RAL7035
  - DGL-MIC: RAL9016

#### ENVIRONMENTAL

- Operating temperature: -5 °C ~ +55 °C (+23 °F ~ +131 °F)
- Storage temperature: -40 °C ~ +70 °C (-40 °F ~ +176 °F)
- Relative humidity: 20 % to 95 %
- Air pressure: 600 to 1100 hPa
- Heat dissipation
  - DNM2-ETH: 20 BTU/hr
  - DGL-MIC: 8 BTU/hr

#### ORDERING INFORMATION

- DNM2-ETH: Digital Ambient Noise Sensing Mic, Ethernet
- DGL-MIC: Flush/Ceiling Mount Microphone

# Accessories

## DLR01 / DLPJ

### Digital Loop Repeater / Digital Loop Power Inject

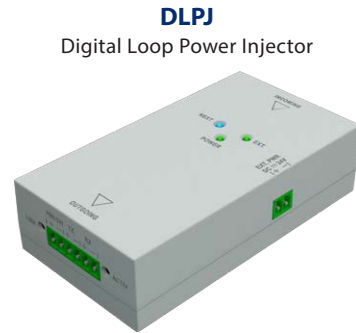

The DLR01 is a digital loop repeater, it can extend the wiring distances of devices including DPM-MAIN, DPM-T5, CD-8DF/16DF, CD-T5DF and DGL-MIC on BOUTIQUE system. The DLR01 is designed for highly secured demand with bi-directional communication. If the control signal of remotes in a redundant loop/daisy-chain wiring is not strong enough, the DLR01 can extend the distance of remotes 250m longer. The DLR01/DLPJ has a 24VDC external power input connector (max. 3A), providing local power for the remotes by using the PSU65-27 power adapter.

### CONNECTION DIAGRAM

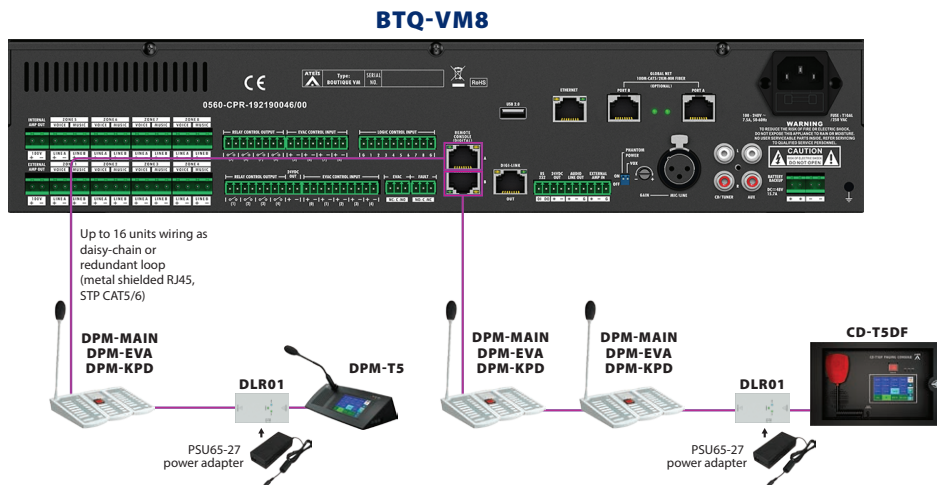

#### ELECTRICAL

- DC power input: 21 VDC ~ 29 VDC
- Power consumption: 0.8W

#### NETWORK

- Extend max. communication distance between remote units: 250m (shielded cable)

#### MECHANICAL

- Dimensions (W x H x D): 56 x 27 x 102 mm (2.2 x 1.1 x 4 inch)
- Weight: 0.2 kg (0.4 lbs)
- Colour: RAL 7035

#### ENVIRONMENTAL

- Operating temperature: -5 °C ~ +55 °C (+23 °F ~ +131 °F)
- Storage temperature: -40 °C ~ +70 °C (-40 °F ~ +158 °F)
- Relative humidity: 20 % to 95 %
- Air pressure: 600 to 1100 hPa
- Heat dissipation: 2.73 BTU/hrr

#### ORDERING INFORMATION

- DLR01: Digital Loop Repeater
- DLPJ: Digital Loop Power Injector
- PSU65-27: Power Supply/Wire/100~240V/DC 27.5V/2.36A

\* The DLR01/DLPJ is not shipped with the power adapter, please order the power adapter if necessary.



## VAT / VA-DLC

### Volume Attenuator / Dummy Load Capacitor Module



#### VAT-35E/120E/200E VAT-35U/120U/200U

The VAT is a volume attenuator equipped with a 10-step attenuation plus a OFF step, it offers precise level control and excellent frequency response to the speaker lines, making it fit in the environment whether in a noisy warehouse or a quiet office. The VAT is applicable for 100 volt/70.7 volt application system.

#### ELECTRICAL

- Input capacity: 100 volt/70.7 volt line
  - VAT-35E/U: 35W
  - VAT-120E/U: 120W
  - VAT-200E/U: 200W
- Transformer output steps @ 100 volt line  
100/70.7/50/35.3/25/17.7/12.5/8.8/6.2/4.4/OFF
- Transformer output steps @ 70.7 volt line  
70.7/50/35.3/25/17.7/12.5/8.8/6.2/4.4/3.1/OFF
- Attenuation per step: 3 dB
- Total attenuation: 27 dB
- Attenuation positions: 10 plus OFF

- Insertion loss
  - VAT-35E/U: <1 dB
  - VAT-120E/U: <1 dB
  - VAT-200E/U: <1 dB
- Frequency response @ <-3 dB
  - VAT-35E/U: 100 Hz ~ 20 kHz
  - VAT-120E/U: 100 Hz ~ 20 kHz
  - VAT-200E/U: 100 Hz ~ 20 kHz

#### MECHANICAL

- Dimensions (W x H x D)
  - EU type: 87 x 86 x 68 mm (3.4 x 3.4 x 2.7 inch)
  - US type: 115 x 70 x 51 mm (4.6 x 2.8 x 2 inch)
- Weight: 0.26 kg (0.57 lbs)

#### ORDERING INFORMATION

- VAT-35E: Volume Attenuator 35W/EU Type
- VAT-120E: Volume Attenuator 120W/EU Type
- VAT-200E: Volume Attenuator 200W/EU Type
- VAT-35U: Volume Attenuator 35W/US Type
- VAT-120U: Volume Attenuator 120W/US Type
- VAT-200U: Volume Attenuator 200W/US Type

#### VA-DLC-100 Dummy Load Capacitor Module 100V SP-line

#### VA-DLC-70 Dummy Load Capacitor Module 70V SP-line

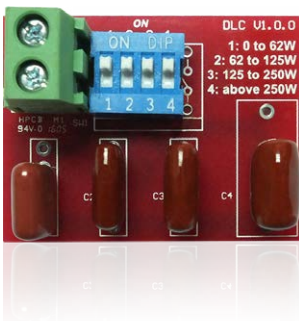

The VA-DLC-100/VA-DLC-70 dummy load capacitor module is used for the speaker line surveillance based on impedance measurement. When a number of speakers are installed with long wires, the VA-DLC-100/VA-DLC-70 can provide a reliable monitoring method to detect the open circuit of entire speaker line even the last speaker.

The VA-DLC-100/VA-DLC-70 has a 4-step DIP switch, and each step refers to individual speaker line power load. To know which step to switch, utilizes the Setup Wizard on the LCD front panel of BTQ-VM4/VM8 controller or BOUTIQUE web browser, and it will automatically calculate the speaker line power load.

#### DIP SWITCH SETTING

- 1 step: 0 to 62W speaker load
- 2 step: 62 to 125W speaker load
- 3 step: 125 to 250W speaker load
- 4 step: above 250W speaker load

#### CERTIFICATIONS AND APPROVALS

Europe	Voice Alarm	EN 54-16 (In process)
Europe	CE/EMI	EN 55032 (In process)
Europe	CE/EMC	EN 61000-3-2 EN 61000-3-3 EN 55020 (In process)
Europe	CE/LVD	EN 60065 (In process)
USA	Safety	UL 60065 (Pending)

#### ELECTRICAL

- Voltage: 100V or 70V loudspeaker line
- Load: 62W, 125W, 250W, above 250W

#### MECHANICAL

- Dimensions (W x H x D): 80 x 10 x 60 mm (3.1 x 0.4 x 2.4 inch)
- Weight: 0.1 kg (0.22 lbs)

#### ENVIRONMENTAL

- Operating temperature: -5 °C ~ +55 °C (+23 °F ~ +131 °F)
- Storage temperature: -40 °C ~ +70 °C (-40 °F ~ +158 °F)
- Relative humidity: 20 % to 95 %

#### ORDERING INFORMATION

- VA-DLC-100: Dummy Load Capacitor Module 100V SP-line, 4pcs/PKG
- VA-DLC-70: Dummy Load Capacitor Module 70V SP-line, 4pcs/PKG

## VA-EOL SL-SENSOR2/SL-SENSOR4 BLKR-60/BLKR-200



End of Line Supervision Board



**VA-EOL**  
End of SP-line Module  
for Multi-branch/3-wire



**SL-SENSOR2 / SL-SENSOR4**  
3 Wire Speaker Line Short Sensor



**BLKR-60 / BLKR-200**  
20kHz Signal Blocker

To monitor the long speaker lines, the VA-DLC-100/70 dummy load capacitor module can be added on the BOUTIQUE PA/VA system to detect the open and short circuit of speaker lines even the last speaker. However, for advanced configuration such as install the VAT volume attenuators in the speaker line for volume control, the impedance of speaker line is changed after adjusting the volume on VAT volume attenuators. Furthermore, for branching the speaker line wiring, a cut of partial branching may not change the overall impedance that obviously. The VA-EOL is the only solution which can adapt the changing impedance and detect open or short circuit for each branch.

By installing the VA-EOL at the end of speaker lines and SL-SENSOR2/SL-SENSOR4 on the zone board of BTQ-VMD/SGD/SLD unit, the system can indicate whether speaker line is open or short circuit within 90 seconds (EN 54-16 requirement), helping to save the analysis time. The installation does not require additional loopback cabling and is powered by BTQ-VMD/SGD/SLD via speaker line without affecting the audio signal. For some application like Nursery, baby may sensitive with 20 kHz monitoring tone, the speaker lines can install BLKR-60/BLKR-200 to filter it.

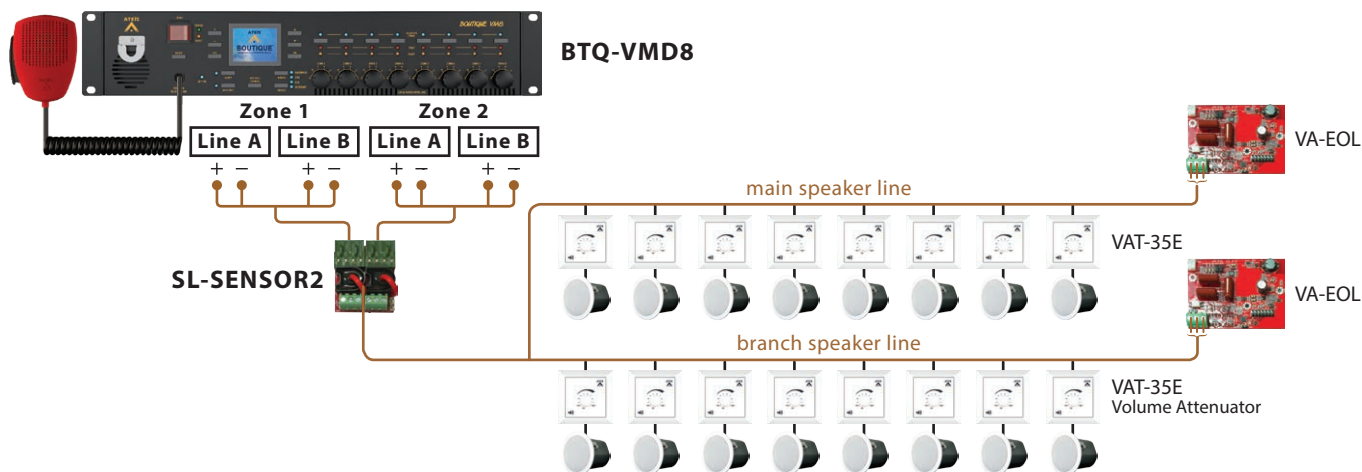

### NOTES

- The supervision of speaker lines is not included the wires which are connected to the VAT volume attenuators.
- Please order the "EOL driver" version of BTQ unit such as BTQ-VMD/SGD/SLD controller/secondary unit when using with VA-EOL module, in order to provide more power to drive the VA-EOL module.
- Max. VA-EOL units
  - Per BTQ-VMD/SGD/SLD unit
    - ◆ Max. 50 VA-EOL (in 1k-ohm)
    - ◆ Max. 15 VA-EOL (in full power 500W)
  - Entire BTQ system
    - ◆ Max. 97 VA-EOL entire local-net system
    - ◆ Max. 6,028 VA-EOL entire global-net system
  - Max. 16 speaker line branches per BTQ-VMD/SGD/SLD zone when using VA-EOL plus VAT volume attenuator

## VA-EOL SL-SENSOR2/SL-SENSOR4 BLKR-60/BLKR-200



### Technical Specifications

#### ELECTRICAL & CONTROL

- Power source: Supplied from BTQ-VMD/SGD/SLD
- Power consumption
  - Maximum input voltage: 120 VRMS
  - Voltage: 70V or 100V loudspeaker line
  - Loudspeaker cable
    - ◆ Maximum length: 1000m
    - ◆ Maximum capacitance: 330 nF
  - VA-EOL: 0.38W
  - SL-SENSOR2/SL-SENSOR4: 90 mW
- Speaker line: Applicable to 70V or 100V speaker line
- Pilot tone detection
  - Frequency: 20 kHz
  - Level: 1.5 ~ 2.5 VRMS

#### CERTIFICATIONS AND APPROVALS

Europe	Voice Alarm	EN 54-16 (In process)
Europe	CE/EMI	EN 55032 (In process)
Europe	CE/EMC	EN 61000-3-2 EN 61000-3-3 EN 55020 (In process)
Europe	CE/LVD	EN 60065 (In process)
USA	Safety	UL 60065 (Pending)

#### MECHANICAL

- Dimensions (W x H x D)
  - VA-EOL: 80 x 10 x 60 mm (3.1 x 0.4 x 2.4 inch)
  - SL-SENSOR2: 41 x 35 x 50 mm (1.6 x 1.4 x 2 inch)
  - SL-SENSOR4: 84 x 35 x 50 mm (3.3 x 1.4 x 2 inch)
  - BLKR-60/BLKR-200: 50 x 25 x 40 mm (2 x 1 x 1.6 inch)
- Weight
  - VA-EOL: 0.1 kg (0.22 lbs)
  - SL-SENSOR2: 0.41 kg (0.9 lbs)
  - SL-SENSOR4: 0.77 kg (1.69 lbs)
  - BLKR-60/BLKR-200: 0.1 kg (0.22 lbs)

#### ENVIRONMENTAL

- Operating temperature: -5 °C ~ +55 °C (+23 °F ~ +131 °F)
- Storage temperature: -40 °C ~ +70 °C (-40 °F ~ +158 °F)
- Relative humidity: 20 % to 95 %

#### ORDERING INFORMATION

- VA-EOL: End of SP-line Module for Multi-branch/3-wire
- SL-SENSOR2: 3 Wire Speaker Line Short Sensor, 2CH
- SL-SENSOR4: 3 Wire Speaker Line Short Sensor, 4CH
- BLKR-60: 20kHz Signal Blocker/60W
- BLKR-200: 20kHz Signal Blocker/200W



DELIVERING YOUR MESSAGE

# System Software

## System Software

### Web Browser Based Configuration and Control



### WEB-BROWSER BASED

Whether it is in a control room from the main building or in a control facility several kilometers away, the operator can control and monitor the entire BOUTIQUE system remotely from web browser (we recommend Mozilla Firefox or Google Chrome).

### PROGRAMMING

Further adjustments such as volume, DSP elements, zone setting, evac paging, event and bell scheduler, audio routing, pre-recorded messages, paging with priority management, zone/amplifier monitor, logging etc. can be easily configured and monitored in real-time.

### SYNCHRONIZATION

If the device setting has been modified, users can select a chosen BTQ-VM4/8 controller as the base configuration, and let the rest of controllers be synchronized with the chosen controller. Or when replacing the broken controller with the new one, configure and synchronize the system with the broken device only.

### ACCESS LEVELS

In order to comply to EN 54-16 standard, multiple users with 1~4 levels can be created and assigned on web browser, each level is with a user account and password for operating/modifying the specific functions.

### FEATURES

- Support multi-languages & custom fonts
- Manage the message files stored in the BTQ-VM4/8 controller or USB flash drive
- Configuration backup/restore via USB flash drive
- Support Syslog function, record all the logs in the BOUTIQUE global-net and local-net system, and transmit to remote PC/laptop with TerraManager software
- Display the used power consumption of BOUTIQUE local-net system(s) and calculate the recommend battery capacity for the DC backup power of the system
- Graphical user interface for event scheduler configuration including messages playing, commands triggering etc.
- With optional DSP function - Sound Masking, the system can reduce the intelligibility of human speech for protecting private speech privacy.

## System Software

### Digital Signal Processing

The BOUTIQUE exclusive web-browser based software is with powerful DSP components, including the 4 bands equalizer, compressor, limiter, ducker, stream out, VoIP, sound masking noise generator, volume control etc.. The programming of DSP functions can be easily done via the intuitive and graphical interface.

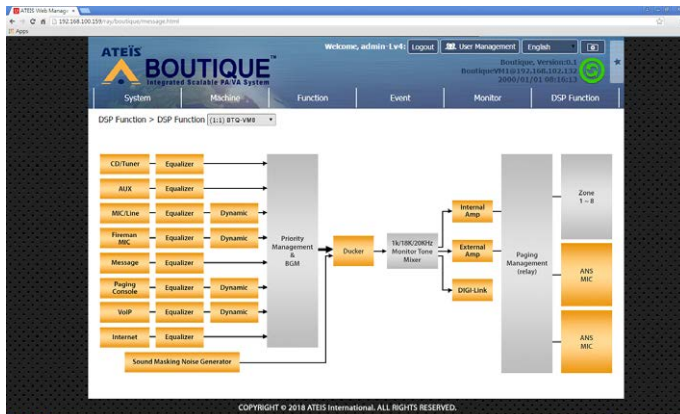

#### ■ INPUT SOURCES

CD/Tuner, Aux, Mic/Line, Fireman Mic, Message, Paging Console, VoIP and Internet

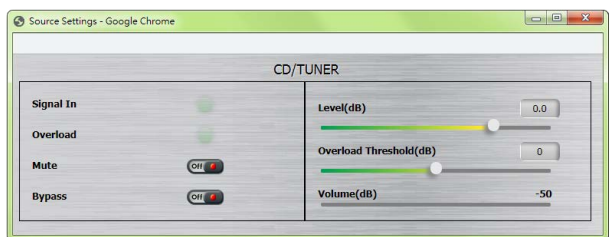

#### ■ INTERNAL/EXTERNAL CH OUTPUT

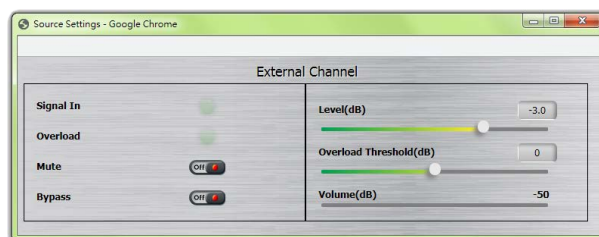

#### ■ 4 BANDS EQUALIZER

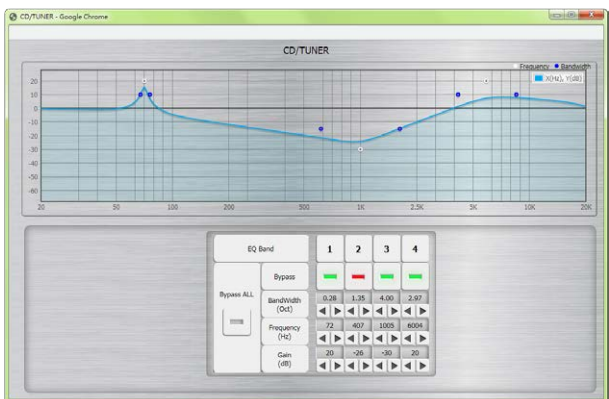

#### ■ STREAM OUT

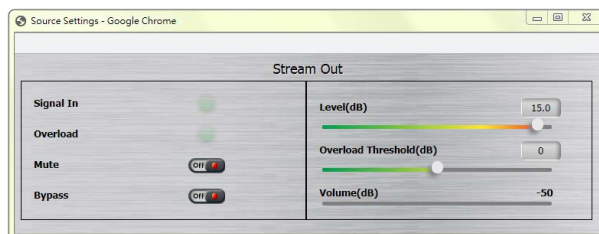

#### ■ AMBIENT NOISE SENSING MICROPHONE

The DNM component is used for adjusting the audio levels depending on the detected ambient noise dynamically. The ambient noise can be measured by DNM2-ETH or DGL-MIC noise sensing microphone.

#### ■ COMPRESSOR & LIMITER

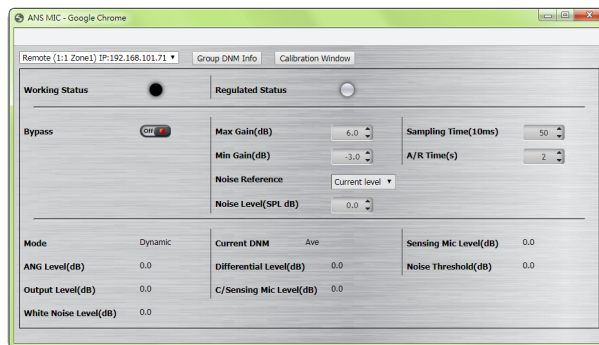
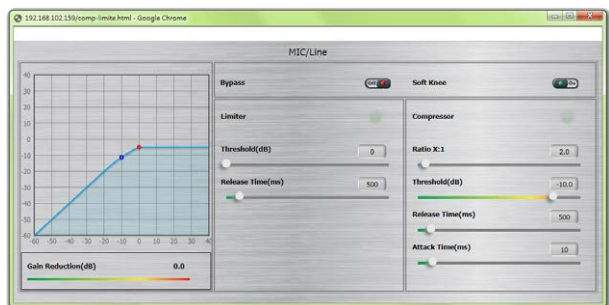



**ATEİS Europe B.V.**  
**Europe & Africa**  
Celsiusstraat 1 - 2652 XN Lansingerland  
(Rotterdam Region), Netherlands  
Tel: +31 (0)10 2088690  
info@ateis-europe.com



**Penton Audio USA**  
**USA, Canada & Latin America**  
21 Sabin Street Pawtucket, RI 02860, USA  
Tel: +1 401-727-1600  
Fax: +1 401-727-0003  
info@penton-usa.com



**ATEİS France**  
8, rue de l'Europe - ZA de Font Ratel,  
38640 Claix, France  
Tel: +33 (0)4 76992630  
contact@ateis.com



**ATEİS China**  
Room 6-2, Yunheng Building, No.1, Lane 1066,  
Sanwu Road, Luotuo Street, Zhenhai District,  
Ningbo, China  
Tel: 0574-86559991  
sales.china@ateis.com.tw



**Penton UK Ltd.**  
**UK & Ireland**  
Unit 2, Teville Industrials, Dominion Way, Worthing  
West Sussex, BN14 8NW, United Kingdom  
Tel: +44 (0)1903 215315  
Fax: +44 (0)1903 215415  
sales@pentonuk.co.uk



**Xavtel Communications RUS Ltd.**  
Russian Federation, 115280, Moscow  
Leninskaya Sloboda str., 26 bld. 28,  
Business Center "Slobodskoy", oco#122  
Tel/Fax: +7 495 803 3655  
info@xavtel.ru.com



**ATEİS Far-East**  
**Far-East Asia**  
2F No.60, Xinghua 2nd Rd. Tanzi,  
Taichung, Taiwan  
Tel: +886 4 25333840  
Fax: +886 4 25333830  
sales@ateis-fareast.com



**ATEİS Suisse SA**  
Avenue des Baumettes 9, 1020 Renens VD,  
Switzerland  
Tel: +41 (0)218812510  
info@ateis.ch



**ATEİS Middle East FZCO.**  
**Middle East & India**  
LIU No. 11 , Dubai Silicon Oasis,  
293640 Dubai, United Arab Emirates  
Tel: +971 (4) 3262730  
Fax: +971 (4) 3262731  
info@ateis.ae



**ATEİS SE PTE. LTD.**  
**South-East Asia**  
Blk 5002 Ang Mo Kio Ave 5, #03-01B TECHplace  
II, Singapore 569871  
Tel: +65 6481 1968  
Fax: +65 6481 1960  
info@ateis-se.com.sg



**ATEİS SE Europe**  
**Serbia**  
Sime Lukina Lazića 12-B, 11040 Belgrade  
Serbia  
Tel: +381 (0)11 40 89 617  
info@ateisseeurope.com



[www.ateis.com](http://www.ateis.com)